

DEPARTMENT OF THE ARMY TECHNICAL MANUAL

DEPARTMENT OF THE AIR FORCE TECHNICAL ORDER

TM 11-612  
TO 31R2-2PRC-101

---

RADIO SETS AN/PRC-8, -8A  
-9, -9A, -10, AND -10A  
OPERATION AND  
ORGANIZATIONAL MAINTENANCE



*DEPARTMENTS OF THE ARMY AND THE AIR FORCE*  
*DECEMBER 1954*

**WARNING**

**DANGEROUS VOLTAGES EXIST IN THIS EQUIPMENT**

**Be careful when working on the 67.5-volt or 135-volt circuits.**

**DON'T TAKE CHANCES!**

TECHNICAL MANUAL }  
No. 11-612 }  
TECHNICAL ORDER }  
No. 31R2-2PRC-101 }

DEPARTMENTS OF THE ARMY AND  
THE AIR FORCE

WASHINGTON 25, D. C., 21 December 1954

RADIO SETS AN/PRC-8, -8A, -9, -9A, -10, and -10A,  
OPERATION AND ORGANIZATIONAL MAINTENANCE

|  | <i>Paragraph</i> | <i>Page</i> |
|--|------------------|-------------|
| CHAPTER 1. INTRODUCTION                                      |                  |             |
| Section I. General .....                                     | 1, 2             | 3           |
| II. Description and data .....                               | 3-12             | 3           |
| CHAPTER 2. PREPARATION FOR OPERATION .....                   | 13-23            | 12          |
| 3. OPERATING INSTRUCTIONS                                    |                  |             |
| Section I. Operation under usual conditions .....            | 24-28            | 24          |
| II. Operation under unusual conditions .....                 | 29-32            | 28          |
| CHAPTER 4. ORGANIZATIONAL MAINTENANCE INSTRUCTIONS           |                  |             |
| Section I. Tools and equipment .....                         | 33, 34           | 29          |
| II. Preventive maintenance services .....                    | 35-40            | 29          |
| III. Lubrication .....                                       | 41, 42           | 32          |
| IV. Weatherproofing .....                                    | 43, 44           | 32          |
| V. Troubleshooting at organizational maintenance level ..... | 45-48            | 32          |
| CHAPTER 5. DESCRIPTION OF AUXILIARY EQUIPMENT .....          | 49-52            | 40          |
| 6. DEMOLITION OF MATERIEL TO PREVENT ENEMY USE .....         | 53, 54           | 43          |
| INDEX .....  |                  | 44          |

\* This manual supersedes TM 11-612/TO 16-30PRCS-6, 21 September 1951, including C 1, 5 November 1953 and C 2, 14 April 1954.

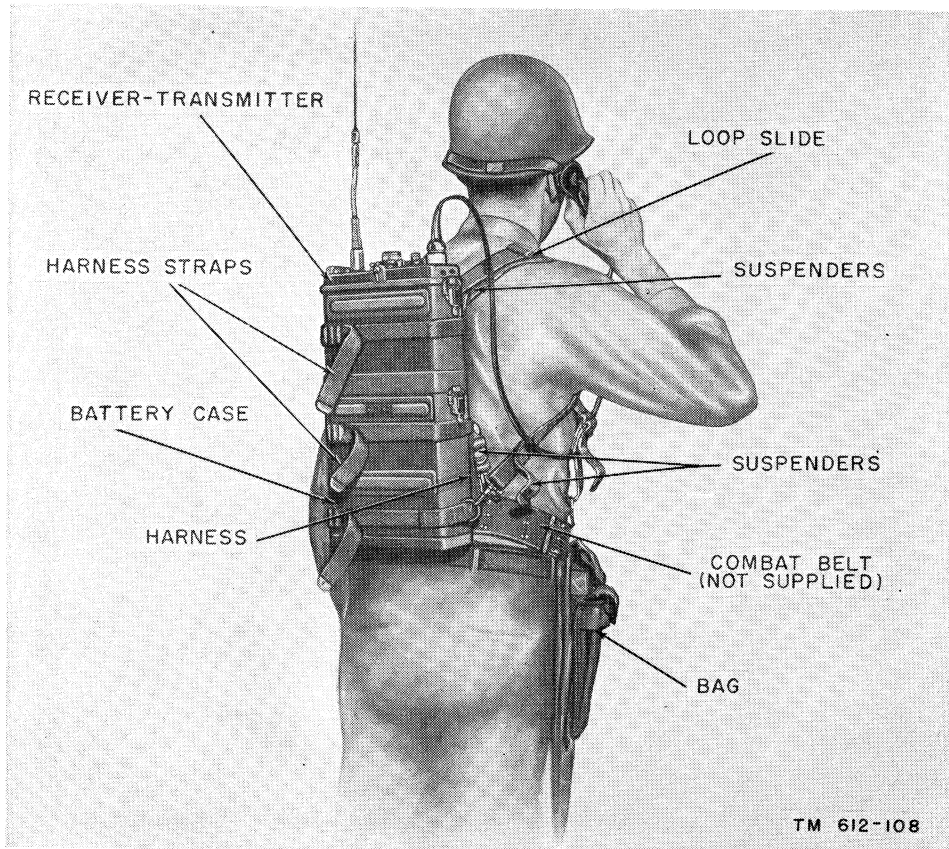

*Figure 1. Radio set AN/PRC-8, -8A, -9, -9A, -10, or -10A, pack mounted.*

# CHAPTER 1

## INTRODUCTION

### Section I. GENERAL

#### 1. Scope of Manual

*a.* This manual contains instructions for installation, operation, and organizational maintenance of Radio Sets AN/PRC-8, -8A, -9, -9A, -10, and -10A. It also includes directions for operation of these radio sets with various auxiliary equipments.

*b.* Official nomenclature followed by (\*) is used to indicate all models of the equipment item covered in this manual. Thus, Handset H-33(\*)/PT (par. 5) represents Handsets H-33/PT, H-33A/PT, H-33B/PT, H-33C/PT, and H-33D/PT.

#### 2. Forms and Records

The following forms will be used for reporting unsatisfactory conditions of Army materiel and equipment.

*a.* DD Form 6, Report of Damaged or Improper Shipment, will be filled out and forwarded as prescribed in SR 745-45-5 (Army); Navy Shipping Guide Article 1850-4 (Navy); and AFR 71-4 (Air Force).

*b.* DA Form 468, Unsatisfactory Equipment Report, will be filled out and forwarded to the Office of the Chief Signal Officer as prescribed in SR 700-45-5.

*c.* DD Form 535, Unsatisfactory Report, will be filled out and forwarded as prescribed in SR 700-45-5 and AF TO 00-35D-54.

*d.* DA Form 11-238, Operator First Echelon Maintenance Check List for Signal Corps Equipment (Radio Communication, Direction Finding, Carrier, Radar), will be prepared in accordance with instructions on the back of the form (fig. 25).

*e.* Use other forms and records as authorized.

### Section II. DESCRIPTION AND DATA

#### 3. Purpose and Use

Radio Sets AN/PRC-8, -8A, -9, -9A, -10, and -10A are portable, frequency-modulated (fm) radio sets that are used for reception and transmission. The radio sets are used with a battery for man-pack operation and with a power supply for vehicular operation. Provision also is made for homing operation (par. 28), remote control operation (par. 27), and relay operation (par. 26).

#### 4. Equipment Characteristics

##### *a. Operating.*

##### *Frequency range, continuous tuning:*

Radio Sets AN/PRC-8 and -8A.....20 to 27.9 mc.  
Radio Sets AN/PRC-9 and -9A.....27 to 38.9 mc.  
Radio Sets AN/PRC-10 and -10A...38 to 54.9 mc.

##### Power source:

Man-pack..... Battery BA-279/U (not supplied with radio set).

Vehicular..... Amplifier-Power Supply AM-598/U (not supplied with radio set).

Calibration..... Built-in calibrator provides calibrated tuning throughout operating range.

Distance range..... About 3 miles.

Weight (man-pack)..... 26 pounds (including components and battery).

##### *b. Technical.*

Number of tubes..... 16 in unlettered models.  
14 in A models.

Type of signal..... Voice, frequency-modulated.

##### Types of antennas:

Long antenna..... Antenna AT-271/PRC (or AT-271A/PRC); 10 feet long, multisection whip type.

Short antenna-----Antenna AT-272/PRC (or AT-272A/PRC) ; 3 feet long, semirigid steel tape.

Microphone input impedance. 150 ohms.

Audio output impedance. 600 ohms.

### 5. Nomenclature Assignments

A list of common names of components that are part of the radio set or used with it is given below:

| Nomenclature   | Common name                               |
|--|---|
| Radio Sets AN/PRC-8, -8A, -9, -9A, -10, and -10A.  | Radio set                                 |
| Radio Receiver-Transmitters RT-174/PRC-8, RT-174A/PRC-8, RT-175/PRC-9, RT-175A/PRC-9, RT-176/PRC-10, and RT-176A/PRC-10. | Receiver-transmitter                      |
| Case CY-744/PRC or CY-744A/PRC.  | Battery case                              |
| Battery BA-279/U-----  | Battery                                   |
| Amplifier-Power Supply AM-598/U.   | Vehicular power supply (or power supply). |
| Antenna AT-271/PRC or AT-271A/PRC.   | Long antenna                              |
| Antenna AT-272/PRC or AT-272A/PRC.   | Short antenna                             |

| Nomenclature  | Common name       |
|---|-------------------|
| Handset H-33(*)/PT-----   | Handset           |
| Control Group AN/GRA-6---                                       | Control group     |
| Homing Antennas AT-339/PRC, AT-340/PRC, and Antenna AT-249/GRD. | Homing antennas   |
| Antenna Equipment RC-292--                                      | Auxiliary antenna |

### 6. Packaging Data

a. When packed for shipment, two Radio Sets AN/PRC-8, -8A, -9, -9A, -10, or -10A are placed in a moisture-vaporproof container and packed in a good, commercial grade, corrugated fiberboard box for domestic use, or in a wooden-cleated plywood or nailed box for oversea use.

b. The size, weight, and volume of a package containing two radio sets for domestic and oversea shipment are as follows: length, 10 inches; width, 18<sup>3</sup>/<sub>4</sub> inches; depth, 12<sup>1</sup>/<sub>2</sub> inches; volume, 1.3 cubic feet; and weight, 55 pounds.

### 7. Table of Components

The list of components of the radio set is presented in the following chart, together with the running spares. The components and spares are shown in figures 2 and 3, respectively.

| Component  | Required No.    |                 |                   | Height (in.) | Depth (in.) | Length (in.) | Dia. (in.) | Volume (cu. ft. packed) | Unit weight (lb.) |
|--|-----------------|-----------------|-------------------|--------------|-------------|--------------|------------|-------------------------|-------------------|
|  | AN/PRC-8 or -8A | AN/PRC-9 or -9A | AN/PRC-10 or -10A |              |             |              |            |                         |                   |
| Radio Receiver-Transmitter RT-174/PRC-8 or RT-174A/PRC-8.          | 1               | -----           | -----             | 9.5          | 3           | 10.5         | -----      | .17                     | 9                 |
| Radio Receiver-Transmitter RT-175/PRC-9 or RT-175A/PRC-9.          | -----           | 1               | -----             | 9.5          | 3           | 10.5         | -----      | .17                     | 9                 |
| Radio Receiver-Transmitter RT-176/PRC-10 or RT-176A/PRC-10.        | -----           | -----           | 1                 | 9.5          | 3           | 10.5         | -----      | .17                     | 9                 |
| Case CY-744/PRC or CY-744A/PRC-----                                | 1               | 1               | 1                 | 9.5          | 3           | 9.5          | -----      | .16                     | 1.5               |
| Battery BA-279/U (required but not supplied as part of radio set). | 1               | 1               | 1                 | 8.5          | 2.37        | 8.5          | -----      | .10                     | 8                 |
| Antenna AT-271/PRC or AT-271A/PRC-----                             | 1               | 1               | 1                 | -----        | -----       | 113          | .75        | .10                     | .33               |
| Antenna AT-272/PRC or AT-272A/PRC-----                             | 1               | 1               | 1                 | -----        | -----       | 36.5         | .75        | .03                     | .5                |
| Antenna Spring Section AB-129/PR-----                              | 1               | 1               | 1                 | .625         | .625        | 8            | -----      | .002                    | 2                 |
| Belt Suspenders M-1945-----  | 1               | 1               | 1                 | 3            | 3           | 36           | -----      | .19                     | .5                |
| Bag CW-216/PR or CW-216A/PR-----                                   | 1               | 1               | 1                 | 3            | 5.25        | 18           | -----      | .16                     | .5                |
| Carrying Harness ST-120/PR or ST-120A/PR-----                      | 1               | 1               | 1                 | 2            | 9           | 14           | -----      | .15                     | .75               |
| Handset H-33(*)/PT-----  | 1               | 1               | 1                 | 3.5          | 3.5         | 8            | -----      | .06                     | .875              |
| Set of running spares-----   | 1               | 1               | 1                 | 5            | 5           | 5            | -----      | .07                     | 2                 |

| Component  | Required No.       |                    |                      | Height<br>(in.) | Depth<br>(in.) | Length<br>(in.) | Dia.<br>(in.) | Volume<br>(cu. ft.)<br>packed | Unit<br>weight<br>(lb.) |
|--|--------------------|--------------------|----------------------|-----------------|----------------|-----------------|---------------|-------------------------------|-------------------------|
|  | AN/PRC-8<br>or -8A | AN/PRC-9<br>or -9A | AN/PRC-10<br>or -10A |                 |                |                 |               |                               |                         |
| Set of running spares for AN/PRC-8, -9, and -10:<br>1 Discriminator Transformer TF-132/U<br>1 dial lamp<br>2 IF Amplifiers AM-427/U<br>1 tube, type 5A6<br>2 tubes, type 1AD4<br>4 tubes, type 5678<br>2 tubes, type 5676<br>2 tubes, type 5672                                      |                    |                    |                      |                 |                |                 |               |                               |                         |
| Set of running spares for AN/PRC-8A, -9A, and -10A:<br>1 Pulse-Sweep Generator 0-325/U<br>1 Discriminator Transformer TF 204/U<br>2 IF Amplifiers AM-427A/U<br>1 dial lamp<br>1 tube, type 5A6<br>1 tube, type 1AD4<br>3 tubes, type 5678<br>1 tube, type 5672<br>3 tubes, type 6286 |                    |                    |                      |                 |                |                 |               |                               |                         |
| Technical Manual TM 11-612.....  | 2                  | 2                  | 2                    |                 |                |                 |               |                               |                         |
| Total (excluding Battery BA-279/U).....  |                    |                    |                      |                 |                |                 |               | 1.03                          | 17.96                   |

Note. This list is for general information only. See appropriate supply publications for information pertaining to requisition of spare parts.

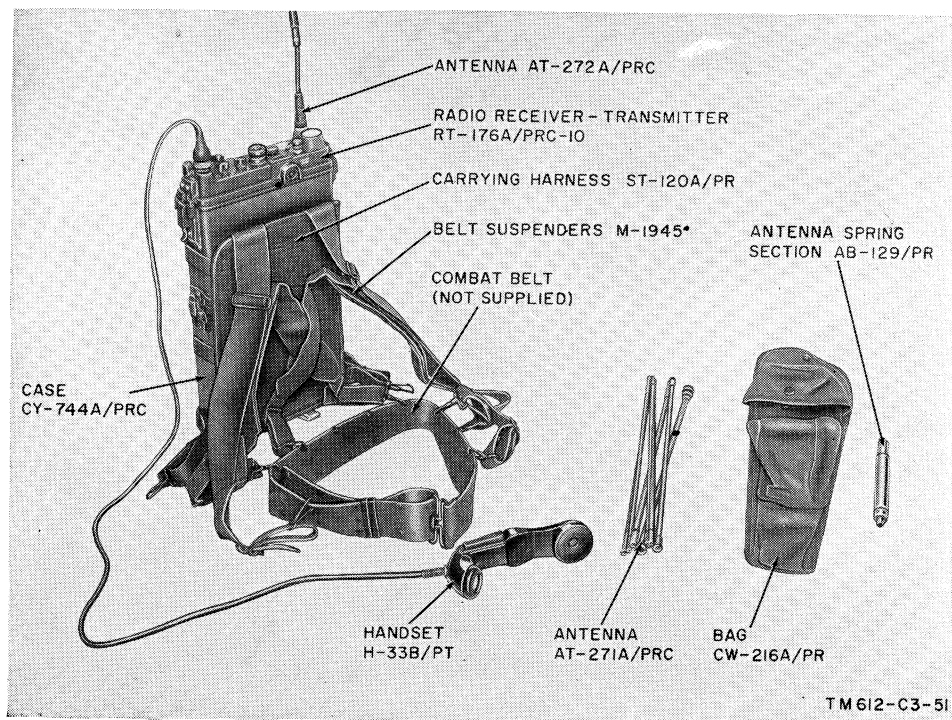

Figure 2. Radio Set AN/PRC-10A, operating components.

NOTE:  
 V8 IS A TYPE 5676 TUBE IN THE  
 FOLLOWING MODELS OF RADIO SET  
 AN/PRC-10:

ORDER NO.  
 1758-P-51  
 3374-P-52

SERIAL NOS.  
 BELOW 6500  
 21562 THRU 21796

IF AMPLIFIERS AM-427/U  
 (U101 TO U105)

DISCRIMINATOR  
 TRANSFORMER  
 TF-132/U (T201)

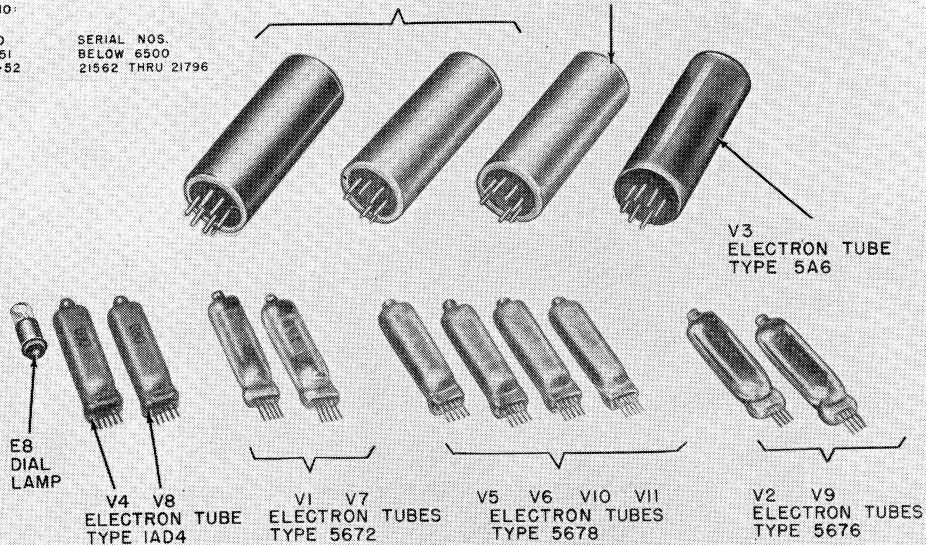

SPARE PARTS (UNLETTERED MODELS)

IF AMPLIFIERS  
 AM-427A/U  
 (FOR U101 TO U104)

DISCRIMINATOR  
 TF-204/U  
 (T201)

PULSE-SWEEP  
 GENERATOR  
 O-325/U  
 (U301)

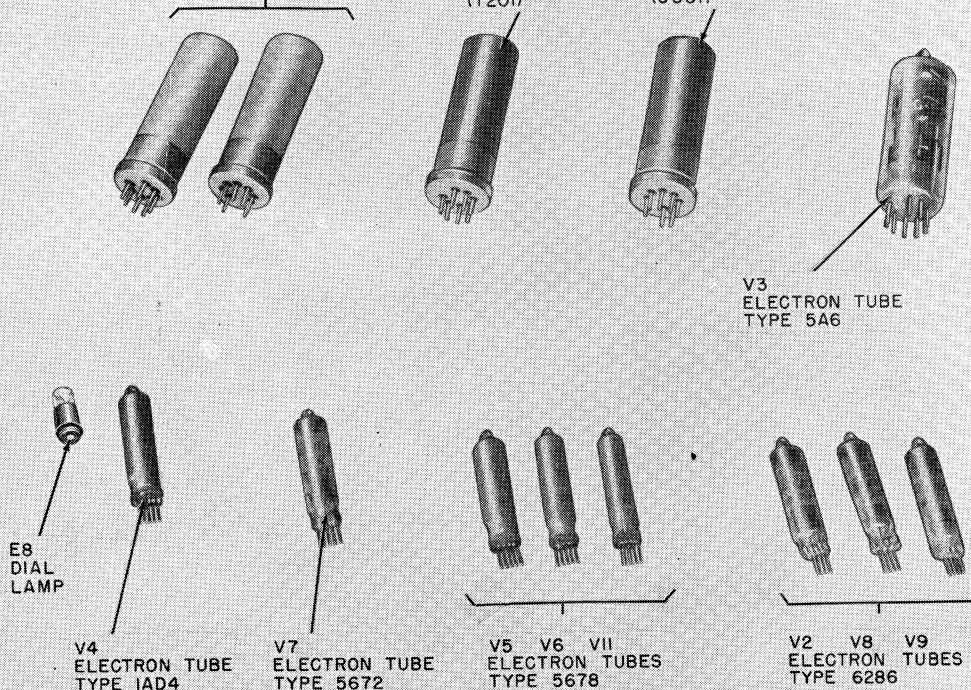

SPARE PARTS (A MODELS)

TM 612-3

Figure 8. Spare parts.



## 8. Description of Radio Sets AN/PRC-8, -8A, -9, -9A, -10, and -10A

The radio set consists of a receiver-transmitter, a battery case, and minor components as shown on figure 2 and listed in paragraph 7. The receiver-transmitter is secured to the battery case by two spring clamps (fig. 4) to form a watertight seal. Runners at the bottom of the battery case may be spread apart as shown to support the radio set on a horizontal surface. Figure 5 shows the receiver-transmitter and battery cases disconnected.

## 9. Receiver-transmitter

The receiver-transmitter consists of a panel and chassis assembly. This assembly is housed

in a case to which it is secured by two spring clamps located on the sides and near the front of the case (fig. 5). The controls and connectors are located on the front panel (fig. 6). The battery plug is located at the end of a short cable at the rear of the receiver-transmitter (fig. 5). The two spring clamps at the front of the receiver-transmitter case are used to secure it to the front panel. The connections between the front panel and the receiver-transmitter case and between the battery case and the receiver-transmitter case are watertight.

## 10. Minor Components

a. Case CY-744/PRC or CY-744A/PRC (fig. 4). Fastened to the bottom of the aluminum

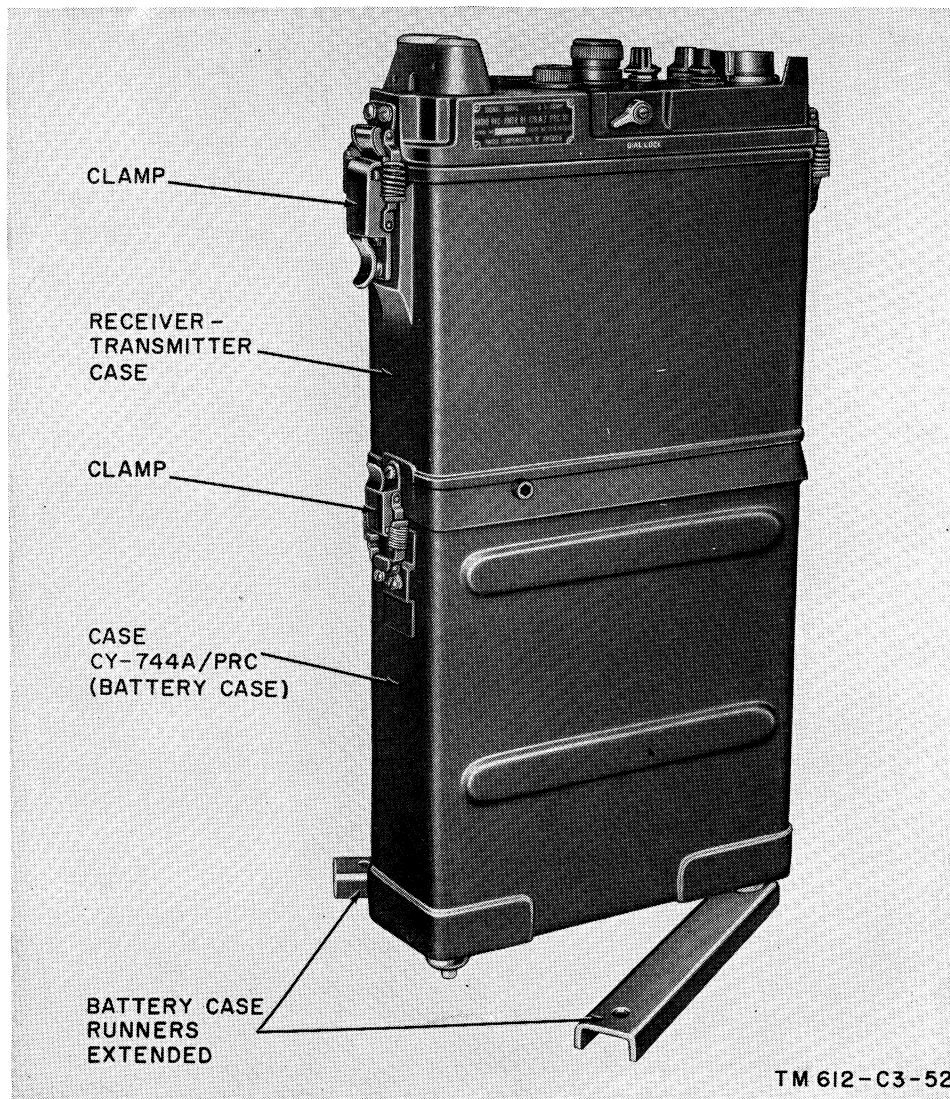

Figure 4. Receiver-transmitter and battery cases, connected.

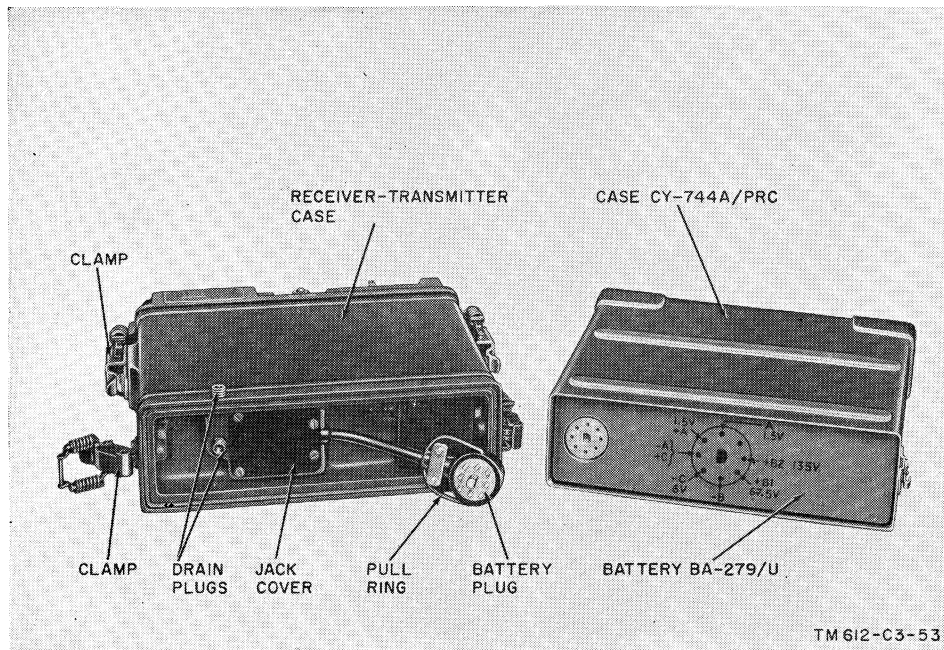

Figure 5. Receiver-transmitter and battery cases, disconnected.

battery case are two runners which prevent the equipment from tipping when operated on the ground. The battery case protects and supports the battery which powers the equipment. A plug on a cable attached to the bottom of the receiver-transmitter fits into the battery socket. The receiver-transmitter has two spring clamps, one on each side, to hold the battery case in place.

b. *Antenna AT-271/PRC or AT-271A/PRC* (fig. 2). This is the long antenna and is made up of seven sections, each one fitting into the ferrule of the previous one. A stainless steel cable, nylon covered, under spring tension and running through the sections keeps them together when in the extended position. When folded, the cable keeps the sections together as a group, thereby preventing the loss of individual sections. Spring tension is provided by a spiral spring in the base section. This antenna is used when maximum range is necessary, such as for two-way unattended relay service or stationary use, and is screwed into the spring section which is in turn screwed into the LONG ANT connector on the control panel.

c. *Antenna AT-272/PRC or AT-272A/PRC* (fig. 2). This is the short antenna and consists of several lengths of flexible steel tape riveted together at the base and at points along their

length, making a tapered antenna 3 feet long. An adjustable elbow is located just above the base. This antenna is used for general service and can be folded into a small space without damage. It is screwed into the SHORT ANT connector on the control panel.

d. *Antenna Spring Section AB-129/PR* (fig. 2). The spring section protects the long antenna and the LONG ANT connector from damage which would otherwise be caused by excessive bending or swaying of the antenna.

e. *Handset H-33(\*)/PT*. The Handset (fig. 7) consists of a microphone for transmitting, an earphone for receiving signals, and a push-to-talk switch. The handset is connected through a cable and 10-contact plug to an AUDIO connector on the control panel of the radio set.

f. *Bag CW-216/PR or CW-216A/PR* (fig. 8). The bag hangs from the operator's combat belt. It carries all the minor components or those not in use during operation. The following items are stored in the compartments:

Handset H-33(\*)/PT

Antenna AT-271/PRC or AT-271A/PRC

Antenna AT-272/PRC or AT-272A/PRC

Antenna Spring Section AB-129/PR

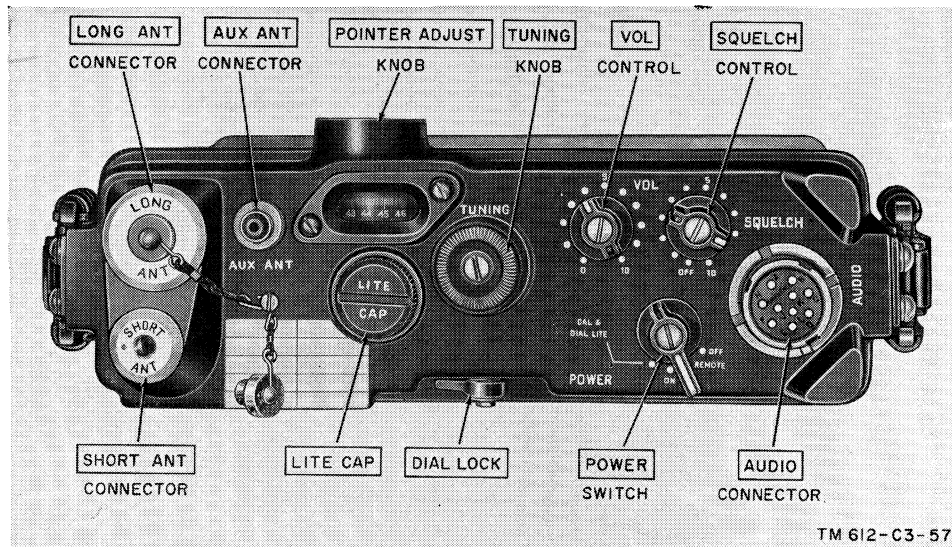

Figure 6. Receiver-transmitter control panel.

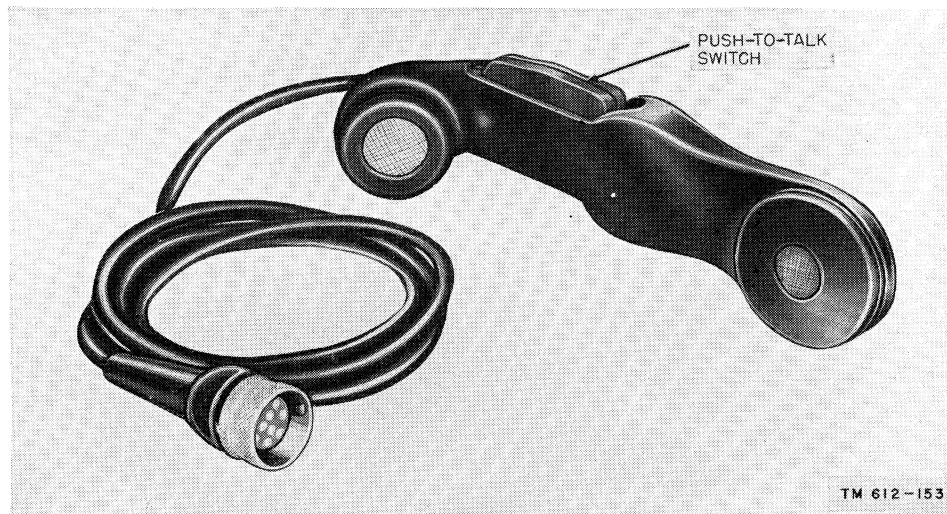

Figure 7. Handset H-33(\*)/PT.

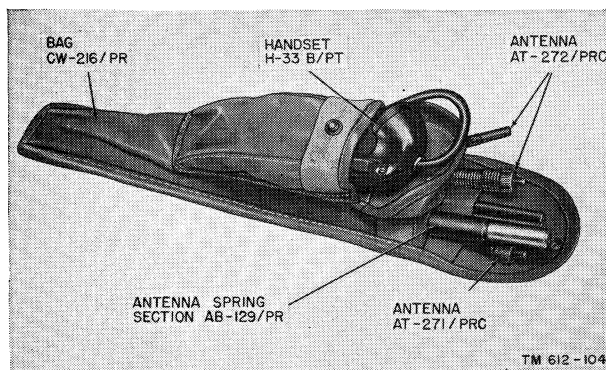

Figure 8. Bag CW-216/PR and minor components.

g. *Belt Suspenders M-1945.* The suspenders (fig. 2) support the operator's combat belt and the equipment in a harness. The suspenders are padded at the shoulders and are adjustable to fit the operator. At the top of the shoulders is a loop slide on each suspender to which the harness is fastened.

h. *Carrying Harnesses ST-120/PR and ST-120A/PR.* The harness (fig. 2) is fastened to the equipment by three adjustable straps. On Carrying Harness ST-120/PR, the bottom strap has two rings sewn into it for securing the

bottom of the harness to the operator's combat belt. On Carrying Harness ST-120A/PR, which is furnished with later models of the radio set, the lowest of the three adjustable straps has two straps attached to it instead of the two rings on Carrying Harness ST-120/PR. Carrying Harness ST-120A/PR also has an additional wide strap at the bottom. Two straps at the top support the entire pack and adjust its position when fastened in the two loop sides of the suspenders.

*i. Battery BA-279/U.* Battery BA-279/U is not supplied with the radio sets and must be requisitioned separately. The actual life of the battery depends on many conditions, such as age, climate, amount of transmitting and receiving time, etc. The approximate expected battery life is given in the following table:

| Rate of use (hr/day) | Battery life |       |
|----------------------|--------------|-------|
|                      | Days         | Hours |
| 2                    | 15           | 30    |
| 4                    | 7.2          | 28.8  |
| 8                    | 2.6          | 20.8  |

*a. Operation.*

| Item No. | Radio Sets AN/PRC-8A, -9A, and -10A  | Radio Sets AN/PRC-8, -9, and -10   |
|----------|--|--|
| 1        | Frequency calibration is provided at 2.15-mc intervals.  | Frequency calibration is provided at each whole number mc point on dial (1-mc intervals).      |
| 2        | Putt-putt-putt sound is heard for a fraction of a second after the handset push-to-talk button is pressed. Operator must wait for this noise to stop before talking. | No putt-putt-putt sound is heard. Operator may talk as soon as push-to-talk button is pressed. |
| 3        | Sidetone is heard during transmission except during relay operation (operator's voice is heard in his own handset receiver).   | No sidetone is heard.  |

## 11. Auxiliary Equipment

The following auxiliary equipments may be used with the radio set:

*a. Amplifier-Power Supply AM-598/U.* Amplifier-Power Supply AM-598/U (fig. 31) powers the radio set in vehicular installations.

*b. Control Group AN/GRA-6.* Control Group AN/GRA-6 (fig. 32) provides for remote control of one or two radio sets.

*c. Homing Antennas.* Homing Antennas AT-339/PRC (fig. 24), AT-340/PRC, and Antenna AT-249/GRD provide for homing operation (direction finding) with the radio set.

*d. Antenna Equipment RC-292.* Antenna Equipment RC-292 (fig. 33) is an auxiliary antenna which extends the distance range of the radio set.

## 12. Differences in Models

Differences exist between the A models and the unlettered models of the radio set. These differences are as follows:

*b. Components.*

| Item No. | Radio Sets AN/PRC-8A, -9A, and -10A  | Radio Sets AN/PRC-8, -9, and -10   |
|----------|--|--|
| 1        | Four IF Amplifiers AM-427A/U (U101 through U104). Each can has a yellow mark on top. These are interchangeable with the if. plug-in cans in the unlettered models.   | Five IF Amplifiers AM-427/U (U101 through U105). Each can has a red mark on top.   |
| 2        | One Discriminator Transformer TF-204/U (T201) has a blue mark. It is not interchangeable with the discriminator plug-in can in the unlettered models.  | One Discriminator Transformer TF-132/U (T201) has a yellow mark.   |
| 3        | One Pulse-Sweep Generator 0-325/U (U301) has a red mark.   | No pulse-sweep generator.  |
| 4        | One calibration oscillator, V9, type 6286 tube.  | Two calibration oscillators, V9 and V10. V9, type 5676 tube; V10, type 5678 tube.  |
| 5        | No afc driver.   | One afc driver V1, type 5672 tube.   |
| 6        | Modulator V2 and receiver oscillator V8, type 6286 tubes.  | Modulator V2, type 5676 tube; receiver oscillator V8, type 1AD4 tube. In some of early models, V8 is a type 5676 tube.       |
| 7        | <p>The following components are interchangeable with their corresponding unlettered components:</p> <p>Case CY-744A/PRC.<br/>           Bag CW-216A/PRC.<br/>           Antenna AT-271A/PRC.<br/>           Antenna AT-272A/PRC.</p> | <p>Case CY-744/PRC.<br/>           Bag CW-216/PRC.<br/>           Antenna AT-271/PRC.<br/>           Antenna AT-272/PRC.</p> |

## CHAPTER 2

### PREPARATION FOR OPERATION

---

#### 13. Siting

(fig. 9)

*a.* Because of the low power and high frequency used, the location of the equipment greatly affects its operating range. Normally, a line-of-sight range can be expected. That is, if the other station can be seen, satisfactory operation is probable. However, an intervening hill or tall building may hamper or prevent contact with the other station. Valleys, depressions, densely wooded areas, and low places are poor sites. Location on a hilltop or tower increases the line-of-sight distance, thereby increasing the range. Locating the equipment under a tree or close to a building may result in unsatisfactory operation because of absorption of the signal. Flat terrain is good. As a general rule, transmission over water is better than over land.

*b.* Operation from a moving vehicle can be satisfactory only when the ignition system is shielded to prevent radio interference. Where shielding is not used or is faulty, the vehicle engine will have to be stopped to prevent interference while operating. When operating from a vehicle, stay away from bridges, hospitals, large trees, and heavily traveled roads, if possible.

*c.* The antennas supplied are designed for man-pack operation. For semipermanent installations, the operating range may be increased and operation made more convenient by using Antenna Equipment RC-292/U. The range between two radio sets, each of which uses Antenna Equipment RC-292, is approximately 12 miles. When one set uses Antenna Equipment RC-292 and the other set uses Antenna AT-271/PRC, the range is approximately 8 miles. A good emergency antenna can be made by a verticle rod or wire connected to the equipment by a coaxial cable (see TM 11-666).

*d.* By using remote operation (par. 17 and 27), the operator can choose an effective site

for the equipment and, at the same time, operate from a fox hole or any other desired position within 5 miles of the equipment. The operator's presence at the radio set location would then be necessary only to change the battery, to change the frequency, or to move the radio set.

#### 14. Uncrating, Unpacking, and Checking New Equipment

*Note.* For used or reconditioned equipment, refer to paragraph 21.

*a. General.* Equipment may be shipped in oversea packing cases or in domestic packing cases. When new equipment is received, select a location where the equipment may be unpacked without exposure to the elements and which is convenient to the permanent or semi-permanent installation of the equipment. The instructions in *b* below apply to equipment shipped in export packing cases, and the instructions in *d* below apply to the equipment shipped in domestic packing cases.

**Caution:** Be careful in uncrating, unpacking, and handling the equipment; it is easily damaged. If it becomes damaged or exposed, a complete overhaul may be required or the equipment may be made useless.

*b. Step-by-step Instructions for Uncrating and Unpacking Export Shipments.*

- (1) Cut and fold back the steel straps.
- (2) Remove the nails with a nail puller. After pulling out the nails, remove the top and one side of the packing case. Do not attempt to pry off the sides and top; the equipment may be damaged.
- (3) Remove the moistureproof barrier and excelsior or corrugated paper covering the equipment inside the case.
- (4) Remove the equipment from its inner case.
- (5) Inspect the equipment for possible damage incurred during shipment.

# THESE PLACES ARE BAD FOR RADIO



VALLEYS



HIGH TENSION LINES

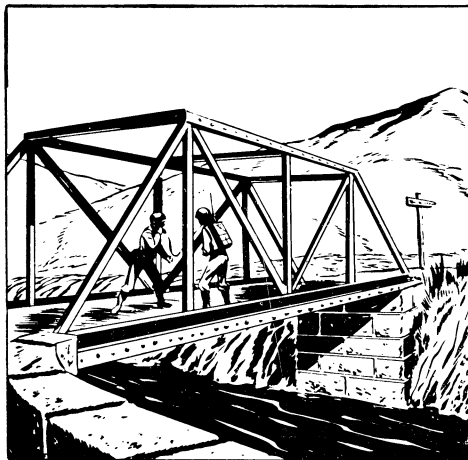

OVERHEAD STEEL BRIDGES



UNDERPASSES

# BUT-THESE ARE GOOD

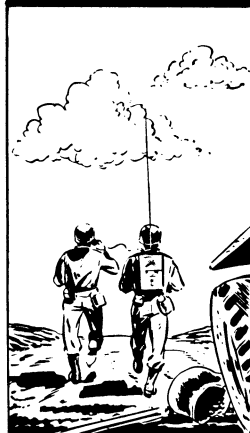

ON LEVEL GROUND



SLIGHT RISE



HIGH HILL

TL13118

Figure 9. Siting.

- (6) Check the contents of the packing case against the master packing slip.

*c. Opening Cardboard Carton and Waterproof Barrier.* No special instructions are needed for opening the waterproof paper barrier and removing the equipment from the cardboard carton.

*d. Unpacking Domestic Packing Cases.* Radio equipment may be received in domestic packing cases. The instructions given in *b* above apply also to unpacking domestic shipments. Cut the metal bands. Open the cartons that protect the equipment or, if heavy wrapping paper has been used, remove it carefully and take out the components.

*e. Checking.* Check the contents against the master packing slip.

*Note.* Save the original packing cases and containers for both export and domestic shipments. They can be used when the equipment is repacked for storage or shipment.

## 15. Installation for Man-pack Operation

### *a. Connecting Battery BA-279/U.*

- (1) Stand the radio set on a bench or on the ground, with the control panel up. Make sure that the POWER switch is at OFF. Release the lower clamps (one on each side of the case) by pushing the topmost part of the clamp downward and outward at the same time.
- (2) Lift the receiver-transmitter off the battery case and set it down, with the battery plug on the bottom (fig. 5) facing the operator. Set the battery on the same surface so that the battery socket is on the side on which the receiver-transmitter plug falls naturally. Hold the pull ring to the rear of the plug and insert the plug into the battery socket, being careful to locate the key on the plug properly. Move the pull ring to the cable side of the plug and slide the battery against the bottom of the receiver-transmitter.
- (3) Keep dirt out of the case. Slide the battery case over the battery until it seats against the receiver-transmitter. Fasten the catches by hooking the

catch loops in the battery case hooks. Push the catches upward and toward the receiver-transmitter case until they snap against the sides. The battery installation is now complete.

**Warning:** Remove the battery when the equipment is not to be used for periods of 1 day or more.

*b. Connecting Antenna AT-272/PRC or AT-272A/PRC* (fig. 2). Use this antenna when maximum range is not required. Screw the threaded end of the short antenna into the connector marked SHORT ANT. If necessary, bend the base of the antenna so that the main portion of the antenna will be vertical.

*c. Connecting Antenna AT-271/PRC or AT-271A/PRC* (fig. 2). Use this antenna when maximum range is required and a semipermanent installation is not feasible. Screw the antenna spring section into the LONG ANT connector on the panel. Extend the long antenna by holding the base section (the heaviest section), and carefully whipping it outward. If all the sections of the antenna are not secure, repeat the above procedure or insert the sections individually by hand. After extending the antenna, screw it into the spring section already installed.

*d. Connecting Handset H-33(\*)/PT* (fig. 2). Insert the plug on the handset cable into the AUDIO connector on the panel. Apply light pressure and turn the plug until it drops in the guides. Push and turn in a clockwise direction as far as it will go.

*e. Placing Radio Set in Carrying Harness ST-120/PR* (fig. 1 and 2). Spread out the harness with the stenciled side down, the wide straps to the right, and the three narrow straps untwisted. Place the radio set in the harness on its back with the panel toward the wide straps. Adjust the position so that the middle narrow strap will come just below the battery case clamps. Fasten the narrow straps by feeding the loose end, from below through the buckle slot close to the center, and then through the slot away from the center. The strap should enter the buckle from below and leave the buckle from below, making an untwisted fastening and returning over itself. The assembly now is ready to be fastened to the suspenders.



*f. Attaching Carrying Harness to Suspender Belt M-1945* (fig. 1 and 2). Clip the suspenders to a combat belt (not supplied with the radio set) and adjust them to fit comfortably. The single clip ends go to the rear and the double clip ends go to the front. On the front, clip the two center clips to the combat belt and adjust the suspenders to fit. Remove the assembled suspenders and combat belt and fasten the wide harness straps through the loop slides, one on each suspender, so that the radio set carries well up on the back of the operator. Cloth guides on each suspender permit folding up the excess length of the wide straps. With Carrying Harness ST-120/PR, clip the remaining clips to the rings on each side of the bottom strap of the harness. Put on the completed assembly and adjust for maximum comfort. Carrying Harness ST-120A/PR has two adjustable straps instead of two rings on the bottom strap. To prevent the radio set from riding up on the back of the operator, adjust the lengths of these short straps and clip their snap hooks to the combat belt. The adjustment of these two bottom straps is not critical. It is determined by the wearer for maximum comfort.

*g. Attaching Bag CW-216/PR or CW-216A/PR* (fig. 1). Attach the bag to the combat belt where it is convenient to reach. The handset and unused items of the equipment are carried in the bag.

## 16. Vehicular Installation

In vehicular installations, the receiver-transmitter is installed on top of Amplifier-Power Supply AM-598/U. This power supply can be used only in vehicles with 24-volt storage batteries. Instructions for installation of the power supply are contained in TM 11-5055 and in the instructions that are supplied with the vehicular installation kit. After the power supply has been installed in the vehicle, install the receiver-transmitter as follows:

### *a. Connections to Power Supply.*

- (1) Set the receiver-transmitter on top of the power supply (fig. 10). See that the POWER switch on the receiver-transmitter is set at OFF. Insert the battery plug of the receiver-transmitter into the receptacle at the rear of

the power supply (fig. 31), keeping the pull-ring (fig. 5) behind the plug and to the cable side of the plug.

- (2) Slide the receiver-transmitter back until it seats against the backrest of the power supply. Hook the rear catch loops of the receiver-transmitter case over the catch retainers of the power supply. Pull the catches forward until they snap against the receiver-transmitter case.
- (3) Connect the cable extending from the front panel of the power supply panel to the AUDIO connector of the receiver-transmitter. Lock the cable connector by pressing it against the AUDIO connector and turning it clockwise.
- (4) Plug the connector on Electrical Special Purpose Cable Assembly CX-2031/U (fig. 31) into the 24V. BATT. receptacle. Connect the two terminal lugs at the other end of the cable to the vehicular storage battery (or junction box). Connect the lug of the shield conductor to the negative terminal; connect the lug of the inner conductor to the +24-volt terminal.

*b. Antenna Connections.* When the radio set is used in an open vehicle, either Antenna AT-272/PRC or AT-271/PRC may be connected, as described in paragraph 15*b* and *c*; or the vehicular antenna may be used if greater range is desired. In a closed vehicle, such as a tank, the vehicular antenna *must* be used. The parts necessary for the vehicular installation are contained in the vehicular installation kit for the radio set. These kits may vary slightly depending on the vehicle. Installation kits are listed in SB 11-131. In general, connections are made as follows:

- (1) Secure Mast Base AB-15/GR to a convenient surface of the vehicle as specified in the vehicular installation instructions.
- (2) Connect the proper mast sections, as indicated in the following chart, to the mast base.

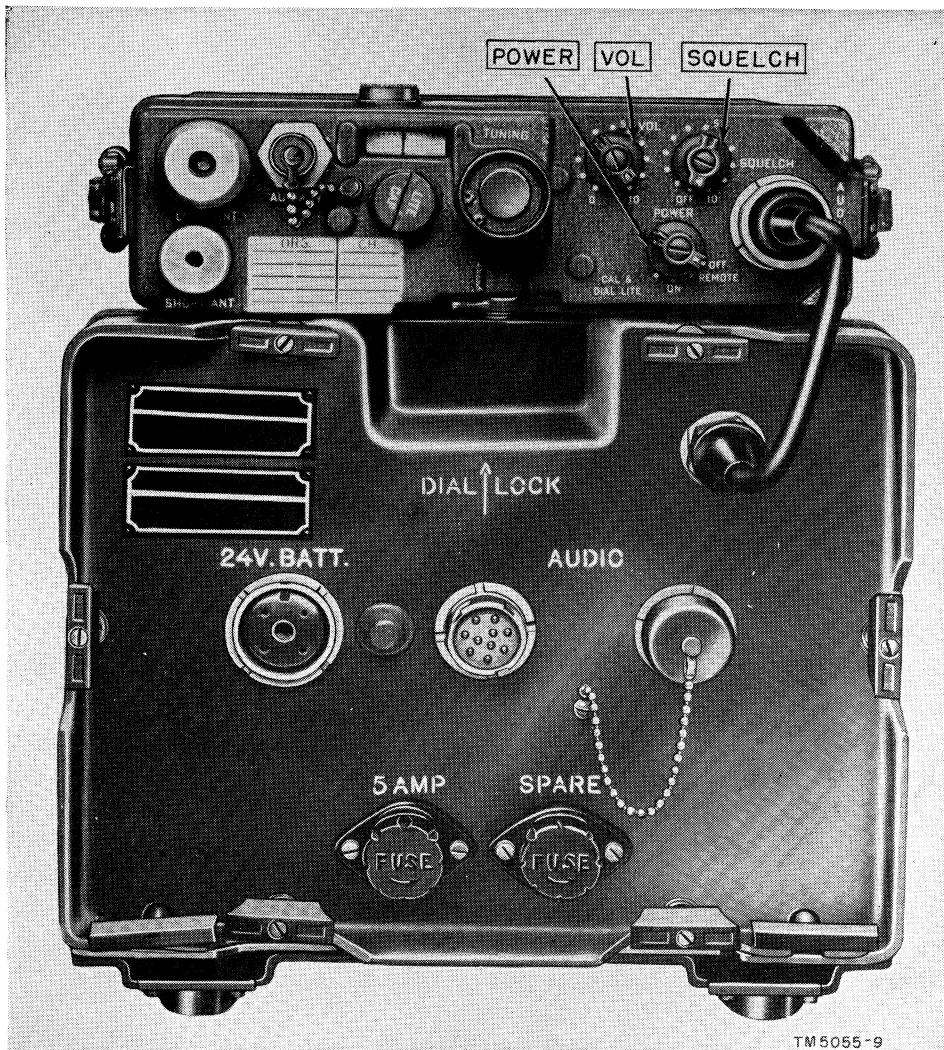

Figure 10. Receiver-transmitter installed on Amplifier-Power Supply AM-598/U.

| Radio set          | Mast sections used               |
|--------------------|----------------------------------|
| AN/PRC-8 and -8A   | MS-116-A<br>MS-117-A<br>MS-118-A |
| AN/PRC-9 and -9A   | MS-116-A<br>MS-117-A<br>AB-24/GR |
| AN/PRC-10 and -10A | MS-117-A<br>AB-24/GR             |

(3) Connect Adapter UG-273/U to the connector at the bottom end of the mast base. Connect RF Cable Assembly CG-530/U to Adapter UG-273/U. Connect the other end of the cable directly to the AUX ANT connector

on the panel of the radio set, or, if more convenient, through Adapter UG-306/U to the AUX ANT connector on the radio set.

*c. Connection of Audio Accessories.* Audio accessories are connected to the AUDIO connectors on the front panel of Amplifier-Power Supply AM-598/U (fig. 11). Two audio accessories may be used at the same time. Appropriate audio accessories are included in the vehicular installation kits. The following audio accessories may be used:

- (1) Handset H-33(\*)/PT (fig. 7)
- (2) Chest Set Group AN/GSA-6 (fig. 12) and Headset-Microphone H-63/U (fig. 13).

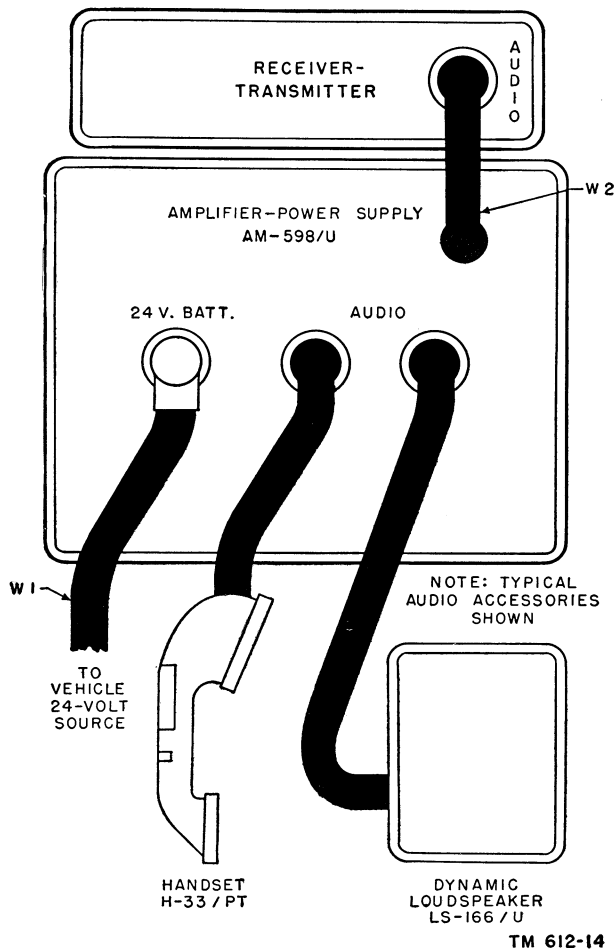

Figure 11. Connection of audio accessories to power supply.

- (3) Dynamic Loudspeaker LS-166/U (fig. 14). Set switch on speaker at VEHICULAR SET.
- (4) Microphone M-29/U (fig. 15).
- (5) Headset Navy Type CW-49507 with Headset Cord CX-1334/U (fig. 16).

### 17. Installation of Control Group AN/GRA-6 (for remote control)

*Note.* Complete the installation procedures described in paragraphs 15 or 16 before installing the control group. However, do not connect any audio accessory to the AUDIO connector of the radio set or of the power supply.

Figure 17 indicates connections between Control Group AN/GRA-6 and the radio set. Be sure that the required batteries have been inserted in Local Control C-434/GRC and in

Remote Control C-433/GRC. Complete details are contained in TM 11-5038.

a. There are two cables in the rear compartment (fig. 18) of Local Control C-434/GRC. Connect the SET 1 cable to the AUDIO connector of the radio set. In remote vehicular operation, connect the SET 1 cable to either one of the AUDIO connectors on Amplifier-Power Supply AM-598/U. (When it is necessary to control two radio sets remotely, connect the SET 2 cable to the second radio set.)

b. Connect the telephone line between the L1 and L2 binding posts of the local control unit and the L1 and L2 binding posts of the remote control unit.

c. Connect handsets to the AUDIO connectors of the local and the remote control units.

### 18. Connections for Relay Operation

A relay station consists of two radio sets (fig. 19) connected by a relay cable (Electrical Special Purpose Cable Assembly CX-1961/U). The relay station operates unattended and passes signals in both directions. Sets 1 and 2 (fig. 20) are tuned to one frequency and sets 3 and 4 are tuned to a second frequency.

a. Connect the relay cable between the AUDIO connectors of two radio sets (sets 2 and 3 of fig. 20), using Receptacle Connectors U-126/U of the relay cable.

b. Connect two handsets to the Receptacle Connectors U-79/U at the ends of the relay cable.

### 19. Connection of Homing Antennas

Use Homing Antenna AT-340/PRC with Radio Sets AN/PRC-8, -8A, -9, -9A; use Homing Antenna AT-339/PRC with Radio Sets AN/PRC-10 and -10A. Antenna AT-249/GRD also may be used with Radio Sets AN/PRC-10 and -10A for frequencies from 47 to 54.9 mc.

a. Extend the two arms of the loop antenna as far as possible. Fit the two sections together to complete the diamond form.

b. Connect the plug at the end of the antenna cord to the AUX ANT connector of the radio set.

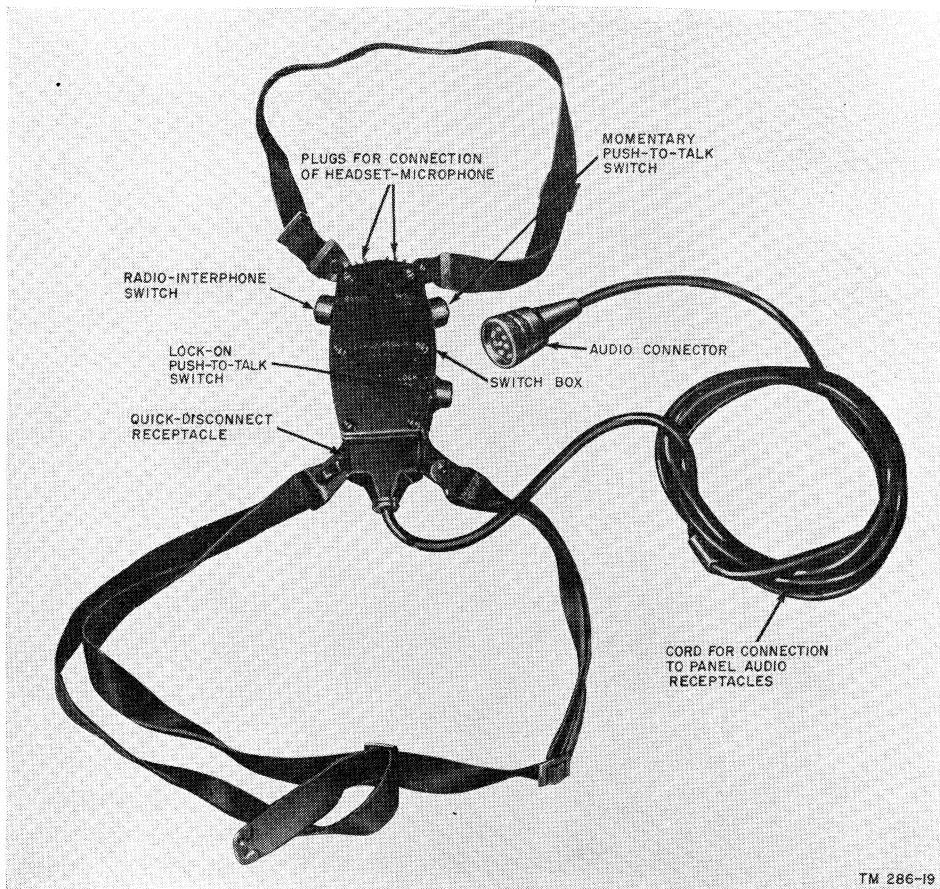

TM 286-19

Figure 12. Chest set group AN/GSA-6.

## 20. Connection of Antenna Equipment RC-292

a. Erect the antenna (fig. 33) as described in TM 11-5020. Use the following chart to

determine the correct number of ground plane and vertical antenna elements required.

| Radio set          | Frequency range (mc) | Total number of vertical antenna sections required | Types of sections |          |          |          | Total number of ground plane sections required | Types of sections per element (3 elements) |          |          |          |
|--------------------|----------------------|--|-------------------|----------|----------|----------|--|--|----------|----------|----------|
|                    |                      |  | AB-21/GR          | AB-22/GR | AB-23/GR | AB-24/GR |  | AB-21/GR                                   | AB-22/GR | AB-23/GR | AB-24/GR |
| AN/PRC-8 and -8A   | 20 to 27.9           | 6  | 3                 | 1        | 1        | 1        | 18   | 3  | 1        | 1        | 1        |
| AN/PRC-9 and -9A   | 27 to 38.9           | 4  | 1                 | 1        | 1        | 1        | 15   | 2  | 1        | 1        | 1        |
| AN/PRC-10 and -10A | 36 to 54.9           | 3  | 1                 | 1        | 1        | 0        | 12   | 1  | 1        | 1        | 1        |



Figure 13. Headset-microphone H-63/U.

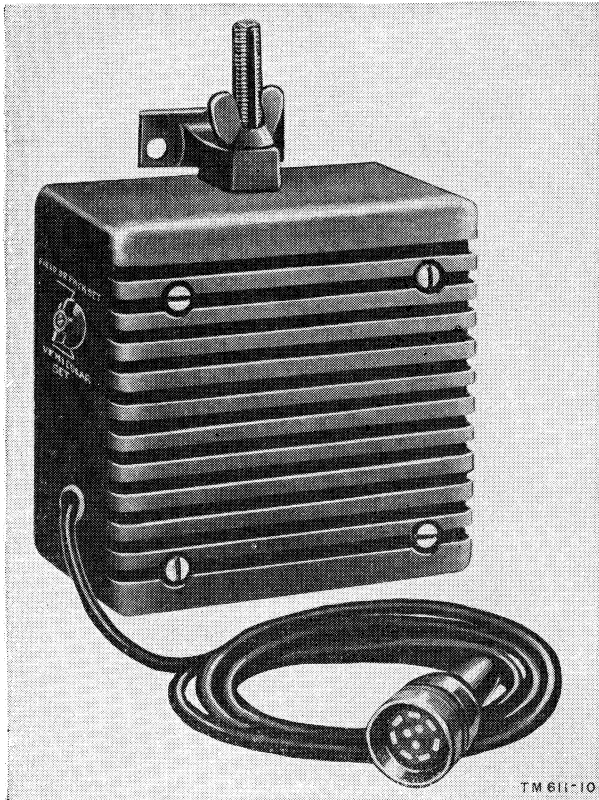

Figure 14. Dynamic loudspeaker LS-166/U.

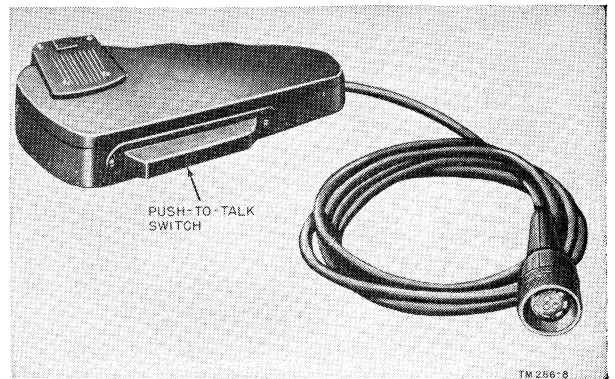

Figure 15. Microphone M-29/U.

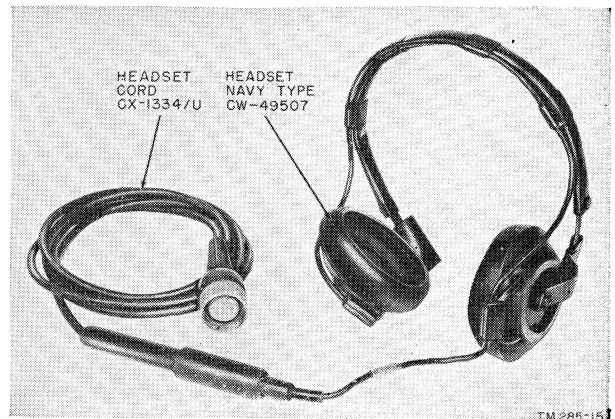
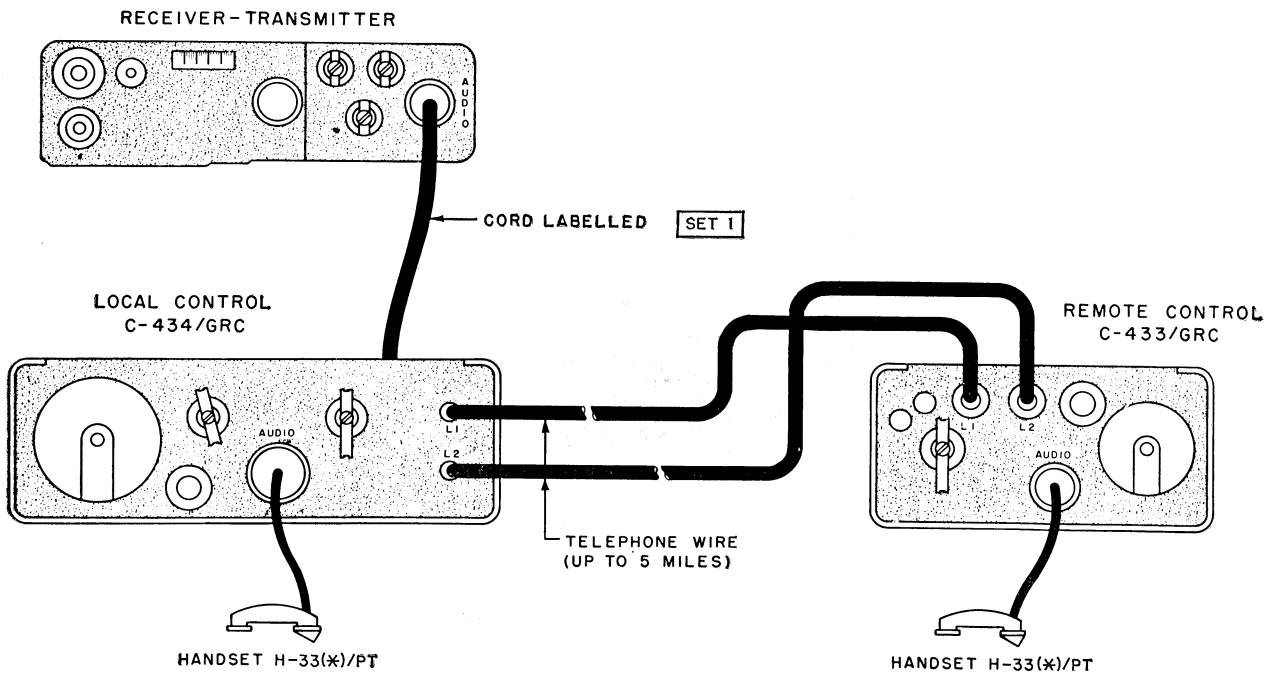

Figure 16. Headset, Navy type CW-49507 with headset cord. CX-1334/U.



TM 612-7

Figure 17. Control Group AN/GRA-16, connections.

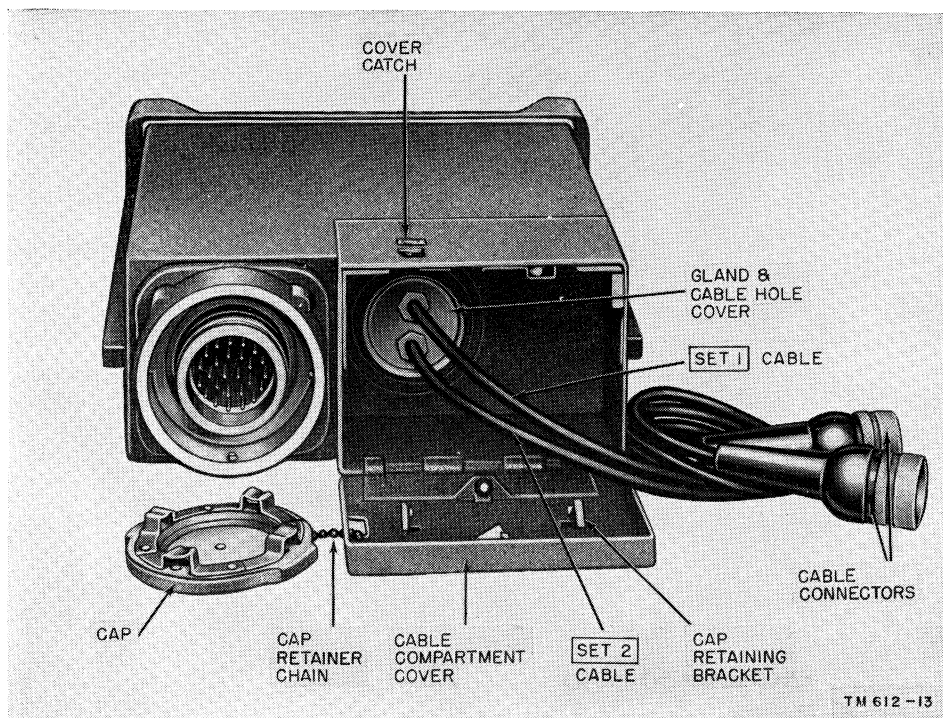

Figure 18. Local Control C-434/GRC, rear view.

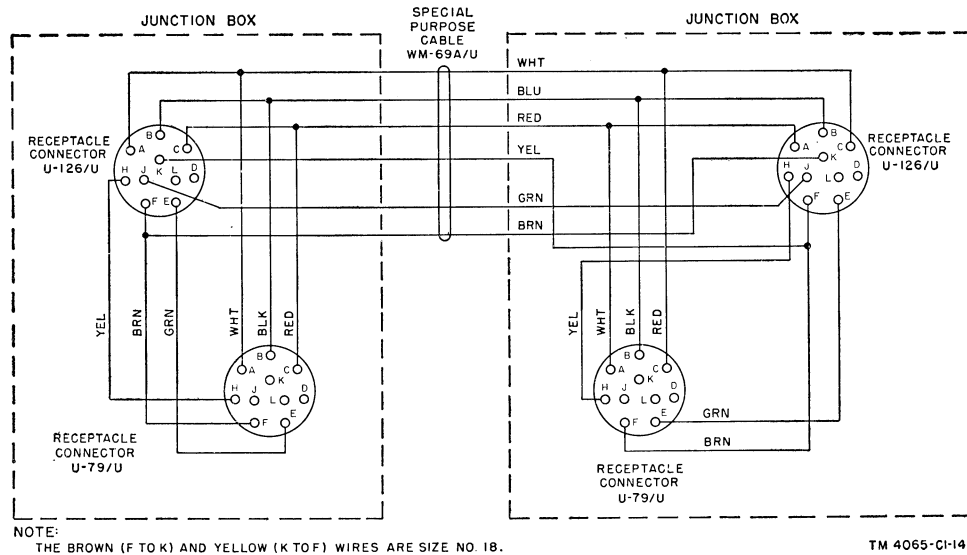

Figure 19. Electrical Special Purpose Cable Assembly CX-1961/U.

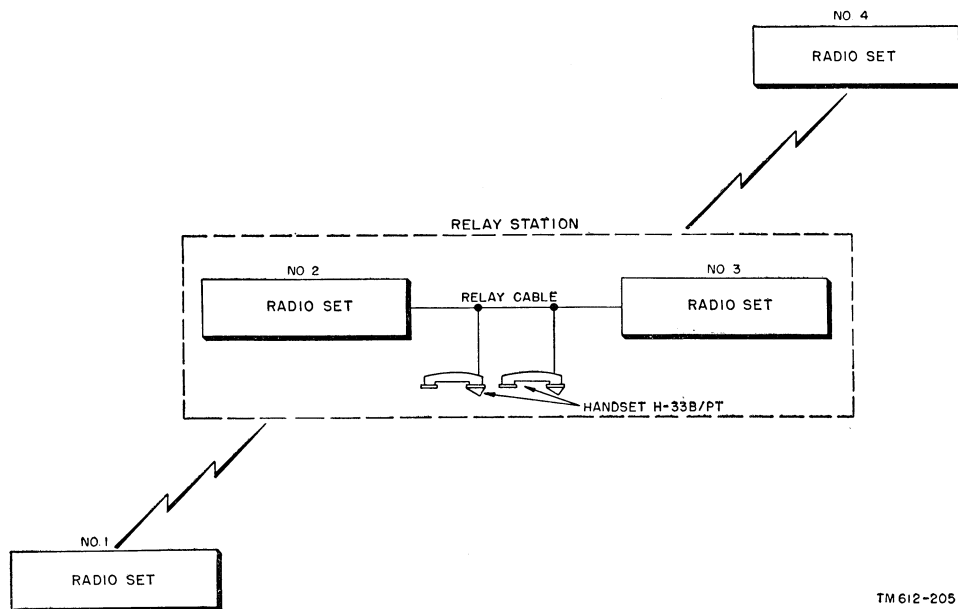

Figure 20. Arrangement of radio sets for relay operation.

b. Connect Adapter UG-225/U to Plug PL-259-A which terminates Cord CG-107/U. This adapter is not supplied with either the radio set or the antenna and must be requisitioned separately.

c. Connect the other end of the adapter to the AUX ANT connector of the radio set (fig. 21).

d. The radio set may now be operated as described in paragraph 24.

## 21. Service on Receipt of Used or Reconditioned Equipment

a. Follow the instructions in paragraph 14 for uncrating, unpacking, and checking equipment.

b. Check the used or reconditioned equipment for tags or other indications pertaining to changes in the equipment.

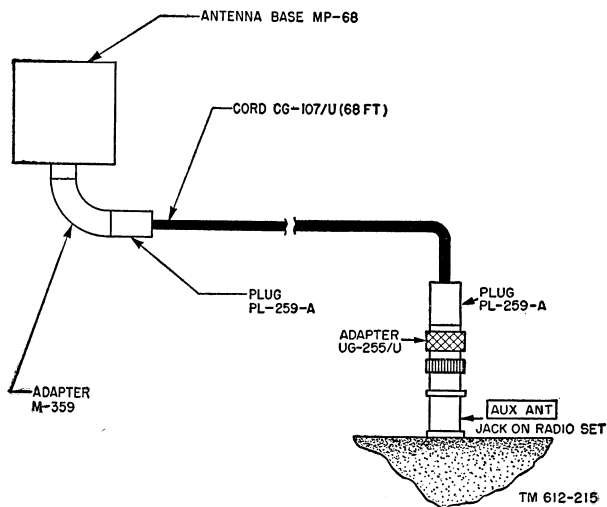

Figure 21. Connection of antenna equipment RC-292.

c. Check the operating controls for ease of rotation. If lubrication is required, refer to the lubrication instructions in paragraphs 41 and 42.

d. Prepare the radio set for operation as described in this chapter.

## 22. Controls and Their Use (fig. 6)

The following chart lists the controls of the radio set and describes their functions. All but three operating controls are located on the control panel. The POINTER ADJUST knob is located just above the panel. The DIAL LOCK is located just below the panel. The push-to-talk button is located on the handset.

| Control                           | Function  |
|-----------------------------------|---|
| POWER switch                      | In ON position, turns power on.<br>In REMOTE position, provides for remote operation from Control Group AN/GRA-6.<br>In CAL & DIAL LITE position, provides for frequency calibration of radio set.<br>Switch is spring-returned to ON position. |
| TUNING knob                       | Tunes radio set to desired frequency.   |
| VOL control                       | Adjusts volume of receiver.   |
| SQUELCH control                   | Cuts off rushing noise when no signal is being received; stops squelch operation when knob is in OFF position.  |
| AUDIO connector                   | Provides connections for audio accessories, local control unit, or relay cable.   |
| LONG ANT connector                | To mount and connect long antenna to radio set.   |
| SHORT ANT connector               | To mount and connect short antenna to radio set.  |
| AUX ANT connector                 | To connect coaxial line from homing or auxiliary antennas (not supplied) to radio set.  |
| LITE CAP                          | To hold dial lamp in place.   |
| POINTER ADJUST knob               | Varies position of pointer on TUNING dial to provide accurate dial frequency calibration.   |
| DIAL LOCK                         | Locks TUNING control so operating frequency cannot be changed accidentally.   |
| Push-to-talk button (on handset). | When pressed, puts radio set in transmit condition.   |

## 23. Frequency Calibration and Tuning

The receiver and the transmitter frequencies are calibrated against an internal crystal calibration circuit to insure accurate tuning.

a. Unlock the TUNING control by turning the DIAL LOCK counterclockwise. Vary the TUNING control until the pointer on the dial is at the frequency calibration point nearest to the desired operating frequency. (In Radio Sets AN/PRC-8, -9, and -10, frequency calibration points are at each whole number megacycle (mc) point on the dial. In Radio Sets AN/PRC-8A, -9A, and -10A, frequency calibration points are at multiples of 2.15 mc and are indicated

by red marks on the dial. For example, four of the calibration points on Radio Set AN/PRC-10A are at 38.70, 40.85, 43.00, and 45.15 mc.) If it is desired to operate at 43.6 mc, set the dial of a Radio Set AN/PRC-10 at 44 mc; set the dial of a Radio Set AN/PRC-10A at 43 mc.

b. Set the VOL control to 10.

c. Set the SQUELCH control to OFF.

d. Hold the POWER switch in the CAL & DIAL LITE position and slowly turn the dial above and below the calibration point while listening on the handset. (Cradle the handset between the ear and shoulder so that two hands are free for this operation.) A high-pitched



whistle should be heard with the pitch dropping until the whistle is inaudible and then rising again. Set the dial at the point where lowest pitch (zero beat) is obtained. Release the POWER switch (which is spring-returned to the ON position).

e. Vary the POINTER ADJUST knob until the dial pointer is at a frequency calibration

point on the dial. This calibrates the radio set for those frequencies which are nearest to this calibration point.

f. Turn the TUNING control until the desired operating frequency appears opposite the pointer. Lock the TUNING control by turning the DIAL LOCK clockwise.

## CHAPTER 3

### OPERATING INSTRUCTIONS

---

#### Section I. OPERATION UNDER USUAL CONDITIONS

#### 24. Basic Operation

Basic operation includes those procedures necessary for sending and receiving from a radio set without auxiliary equipment. It is the same for man-pack or vehicular operation.

##### *a. Starting.*

- (1) Turn the SQUELCH control to OFF.
- (2) Turn the VOL control to its extreme clockwise position.
- (3) Turn the POWER switch to ON.
- (4) Tune the radio set to the desired frequency as described in paragraph 23.

*b. Volume and Squelch Adjustments.* When the SQUELCH control is at OFF, a rushing noise is heard in the handset (or other audio accessory). If the sound is too loud, reduce the volume by turning the VOL control counterclockwise until a desirable level of sound is obtained. Slowly turn the SQUELCH control clockwise until the rushing noise stops. Do not turn the control more than necessary to stop the rushing noise as this reduces the ability of the receiver to pick up weak signals.

*c. Reception.* When the POWER switch is at ON, the radio set is in the receive condition and will pick up fm signals that are on its frequency.

*d. Transmission.* Press the push-to-talk button on the handset (or other transmitting audio accessory) and talk into the microphone. (With radio set AN/PRC-8A, -9A, or -10A a putt-putt-putt sound is heard for a fraction of a second after the push-to-talk button is pressed. Wait for this sound to stop before talking into the microphone. What is spoken into the handset microphone is heard as sidetone in the handset receiver on the A models. There is no sidetone with the unlettered models.) Release the button to listen.

*e Stopping.* Turn the POWER switch to off. If the radio set is not to be used for a day or longer, remove the battery from its case to prevent corrosion.

#### 25. Antijamming

If the receiver is being jammed, notify your superior officer immediately. *Do not stop operating.* Follow the instructions in *a* through *c* below.

*a.* Vary the TUNING knob first to one side, then to the other side of the assigned frequency. It often is possible to obtain better reception on one side or the other.

*b.* Slowly change the position of the antenna from vertical to horizontal.

*c.* Locate the set so that a jeep, truck, tank, tree, earth mound, or some other obstruction is between the source of the jamming signal and the radio set.

*d.* The enemy may be uncertain as to his jamming success and may move to another frequency. *Continue to operate.* Communication then will be reestablished. Also, continued operation on the frequency that is being jammed keeps the enemy jamming signal at that frequency. Another set then may be operated on another frequency without interference while the jamming signal is kept at what the enemy believes is your active communicating frequency.

*e.* Request a change in frequency and call sign.

#### 26. Relay Operation

Two radio sets are set up as a relay station as described in paragraph 18. The handset near set No. 2 (fig. 20) is used for operation with set No. 2; the handset near set No. 3 is used for operation with set No. 3

a. Tune set No. 2 to the frequency of set No. 1 and tune set No. 3 to the frequency of set No. 4 (par. 23). It is desirable that the frequencies of sets No. 2 and 3 should differ by at least 2 mc to avoid interference.

b. Make volume and squelch adjustments on set No. 2 (par. 24a and b). Set the SQUELCH control just a little higher (more clockwise) than is necessary to squelch the radio set. (In relay operation, this is necessary to prevent chattering of the squelch relay in the radio set.)

c. Make volume and squelch adjustments on set No. 3 (par. 24a and b). Set the SQUELCH control just a little higher than necessary to squelch the radio set.

d. Before leaving the relay station, check for proper operation. A signal transmitted by set No. 1 should be received by set No. 2 and retransmitted by set No. 3 to set No. 4. Similarly, a signal transmitted by set No. 4 should be received by set No. 3 and transmitted by set No. 2 to set No. 1. Signals may be monitored by means of the handsets at the relay station.

## 27. Remote Control Operation

a. *Telephone Operation.* Telephone operation enables direct two-way communication over the telephone line between operators at the local and remote control units. This enables the operator at the remote control unit to advise the operator at the local control unit whether the remote control of radio reception and transmission is satisfactory, and if not, what adjustments to make on the control panel of the radio set. Telephone communication between the local and remote control units is possible only when the switches on these units are in certain specified positions as described below. Each local and remote control unit has a 20-cycle ringing generator and a bell. When an operator at either control unit cranks the ringing generator knob located on the panel of the control unit, the bell at the other unit rings regardless of the switch positions on the control panel. The operator at that unit is thus made aware of the desire of the first operator to communicate with him by telephone, and he sets the switches on the control panel as follows:

- (1) At the local control unit (fig. 22), set the REMOTE switch at the TEL

ONLY position and the LOCAL switch at the TEL position.

- (2) At the remote control unit (fig. 23), set the SELECTOR switch at the TEL position.
- (3) Press the push-to-talk button on the handset (at either the local or remote position) and talk into the microphone. Release to listen.

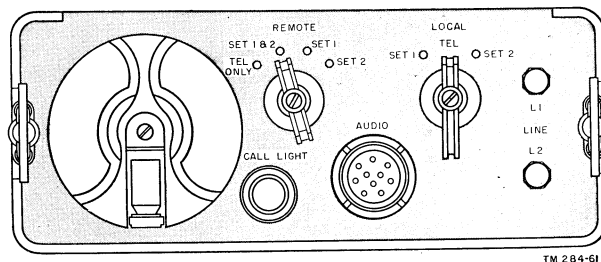

Figure 22. Local control C-434/GRC, controls.

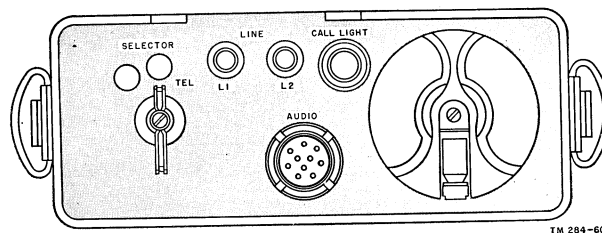

Figure 23. Remote control C-433/GRC, controls.

### b. Operation of Radio Set from Local Control Unit.

- (1) Put the radio set in operation as described in paragraph 24.
- (2) Hold the LOCAL switch (spring-return) on the local control unit (fig. 22) at the SET 1 position, press the push-to-talk button on the handset, and talk into the microphone of the handset when transmitting; release either switch to listen.
- (3) Turn the POWER switch on the radio set to OFF when the set is not being used.

**Caution:** Do not crank the ringing generator handle at the remote or local units except for telephone operation as described in a above.

### c. Operation of Radio Set from Remote Control Unit.

- (1) Put the radio set in operation as described in paragraph 24. Set the POWER switch on the radio set at REMOTE.
- (2) At the local control unit, set the LOCAL switch at the TEL position and the REMOTE switch at the SET 1 position.
- (3) At the remote control unit, set the SELECTOR switch at the left write-in position.
- (4) Momentarily press the push-to-talk button on the handset at the remote control unit. This turns power on in the radio set. If the radio set does not operate, reverse the leads at L1 and L2 of the remote control unit and again press the push-to-talk button momentarily.
- (5) Press the push-to-talk button of the handset to talk and release to listen.
- (6) To turn off the power at the radio set from the remote control unit, turn the SELECTOR switch to the right write-in position and momentarily press the push-to-talk button on the handset.

## 28. Homing Operation

*a.* Set the radio set in operation as described in paragraphs 19 and 24 except that the SQUELCH control must be at OFF.

*b.* Set the SENSE-NORMAL switch of the homing antenna at NORMAL (fig. 24). Set the signal level switch at position 1.

*c.* Set the tuning knob (fig. 24) to the desired operating frequency. (This is an approximate setting.)

*d.* Grasp the antenna by its handle and hold it above the head in an upright position (fig.

24). Rotate the loop until a maximum signal is heard in the handset. Adjust the tuning knob for a maximum signal. If an equally strong signal is obtained for all directions of the loop antenna, set the signal level switch to position 2, 3, or 4, as necessary to reduce the signal strength. This enables a maximum and minimum signal to be obtained as the direction of the loop is changed.

*Note.* *Maximum signal* is indicated by minimum rushing noise when an unmodulated signal (no voice) is used, and by maximum voice signal when a voice signal is used. The edges of the loop are now in line with the transmitter. *Null* is indicated by maximum rushing noise when an unmodulated signal is used, and by minimum voice signal when a voice signal is used. The loop is now broadside to the transmitter. Generally better results are obtained when an unmodulated carrier is used.

*e.* Rotate the antenna one-half turn (180°) from the position of maximum signal obtained in *d* above. If the maximum signal is not equal to that obtained in *d* above, adjust the tuning knob until it is.

*f.* Set the SENSE-NORMAL switch at SENSE and note the signal strength.

*g.* Rotate the antenna one-half turn from the position in *f* above and note the signal strength.

*Note.* If signals of equal strength are obtained in *f* and *g*, set the signal level switch to position 2, 3, or 4 to obtain a weaker signal. Then repeat the procedure in *f* and *g* until signals of unequal strength are obtained.

*h.* Rotate the loop in the direction of the stronger signal. The arrow on the antenna control box (or on the loop) then will point toward the transmitter.

*i.* Set the SENSE-NORMAL switch at NORMAL. Rotate the antenna one-quarter turn (90°) to obtain a null. Use the null for proceeding toward the transmitter. If the null is broad, rotate the loop back and forth to find the center of the null.

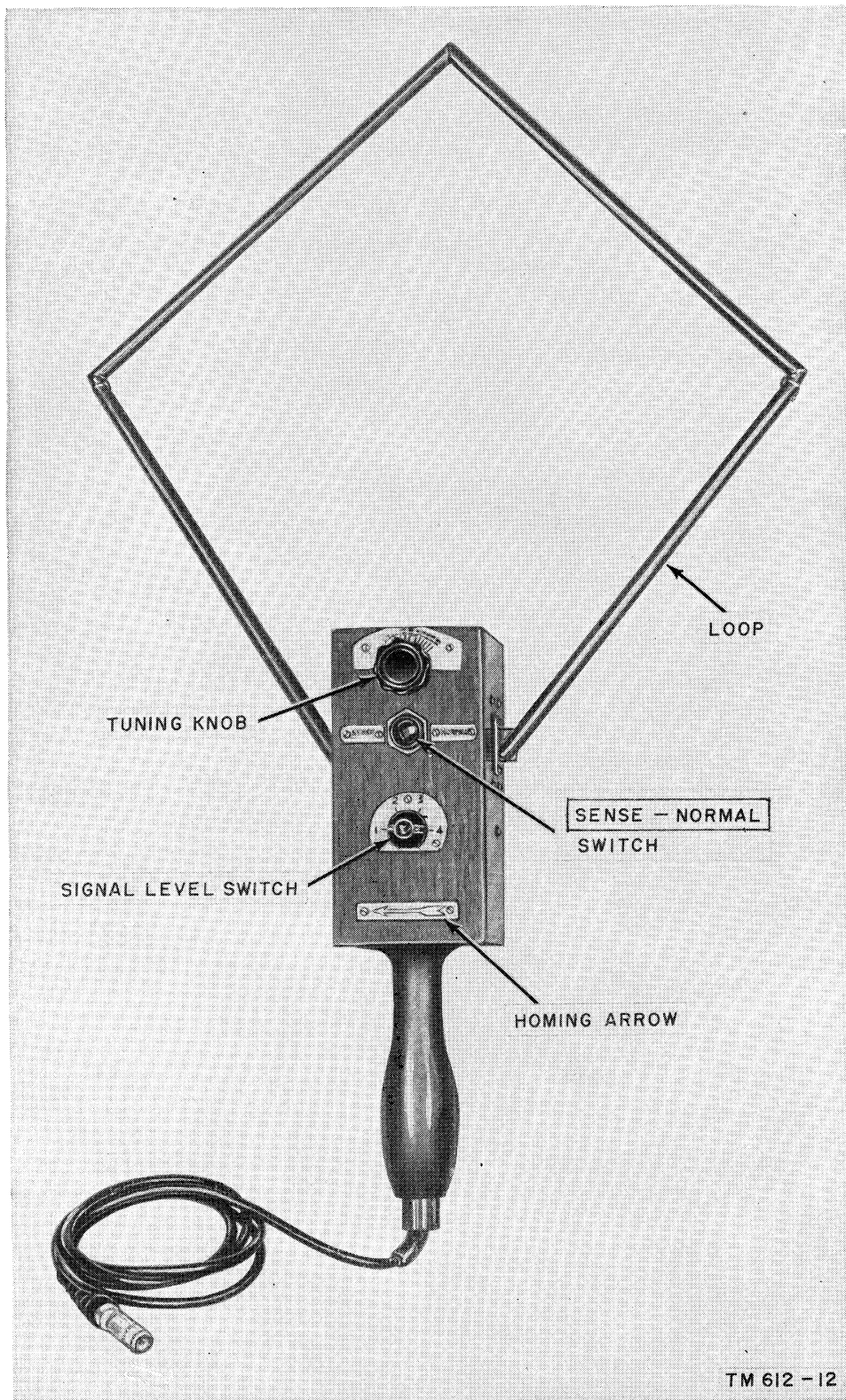

Figure 24. Homing antenna AT-339/PRC or AT-340/PRC.

## Section II. OPERATION UNDER UNUSUAL CONDITIONS

### 29. General

The operation of the radio set may be difficult where extreme cold, heat, moisture, or sand conditions prevail. Procedures for reducing the effects of these unusual operating conditions are outlined below.

### 30. Operation in Arctic Climates

*a.* Heavy coatings of frost gather on mouth-type microphones in extreme cold weather when the microphones are used in the open air or in a cold room. A Pliofilm membrane covers the microphone of Handset H-33(\*)/PT and reduces the possibility of frost clogging the holes of the cap and affecting transmission. If this membrane should tear, replace it with a new one. If possible, have a spare handset ready in case the one in use fails to function properly.

*b.* Place a knitted woolen cap over the receiver of the handset if it is not equipped with a rubber earpiece. If a handset is used without the rubber earpiece, the edges of the ears may freeze without the operator being aware of this condition. Do not flex the rubber earpiece because this may damage it. If water gets into the handset receiver, or if moisture condenses within it, the water may freeze and prevent the handset receiver from operating. When this happens, remove the bakelite cap and remove the ice.

*c.* When equipment which has been exposed to the cold is brought into a warm room, moisture will condense on it until it has reached room temperature. Do not remove the receiver-transmitter from its case until it has reached room temperature. This prevents the formation of moisture on all parts within the case. When the equipment has reached room temperature, dry it thoroughly.

*d.* Use Battery BA-2279/U, if available.

*e.* Use whatever means are available to protect the dry battery against the cold, otherwise the battery will fail. Preheat the batteries, if possible. To prevent heat loss, place them in bags lined with kapok, spun glass, fiber materials or animal skins. If such bags are not available, wrap the radio set in woolen clothing or any other material that will protect the batteries from the cold.

*f.* Turn the POWER switch to ON five minutes before communication is to be es-

tablished with the radio set. This provides a warm-up period for the radio set and results in more stable operation.

### 31. Operation in Tropical Climates

When operated in tropical climates, radio equipment may be installed in tents, huts, or when necessary, in underground dugouts. When equipment is installed below ground and when it is set up in swampy areas, moisture conditions are more acute than normal in the tropics. Ventilation is usually very poor, and the high relative humidity causes condensation of moisture on the equipment whenever the temperature of the equipment becomes lower than the surrounding air. To minimize this condition, use any convenient method to keep the temperature of the equipment just above that of the air.

### 32. Operation in Desert Climates

*a.* Conditions similar to those in tropical climates often prevail in desert areas. Use the same measures to insure proper operation of the equipment.

*b.* The main problem which arises with equipment operation in desert areas is the large amount of sand or dust and dirt which enters the moving parts of radio equipment. The case of the receiver-transmitter is dustproof and should not be removed unless adequate shelter is available to prevent dust from entering the equipment. A dustproof shelter is ideal but is seldom available since it requires air conditioning. The next best precaution is to make the shelter as dustproof as possible with available materials when the case must be opened or the equipment stored. Hang wet sacking over the windows and doors, cover the inside with heavy paper, and secure the side walls of the tents with sand to prevent their flapping in the wind.

*c.* Never tie signal cords, power cords, or other wiring connections to either the inside or the outside of tents. Desert areas are subject to sudden squalls which may jerk the connection loose or break the lines.

*d.* Be careful to keep the equipment as free of dust as possible. Make frequent preventive maintenance checks. Pay particular attention to the condition of the lubrication of the equipment. Excessive amounts of dust, sand, or dirt that come into contact with oil and grease result in grit, which will damage the equipment.

## CHAPTER 4

### ORGANIZATIONAL MAINTENANCE INSTRUCTIONS

---

#### Section I. TOOLS AND EQUIPMENT

##### 33. Tools and Materials Supplied with the Radio Set

*a. Tools.* Only alinement tools are supplied with the equipment. However, these are to be used only when following instructions in TM 11-4065, and only at the third or higher echelons.

*b. Materials.* A complete set of running spares is supplied with the equipment (par. 7). Organizational maintenance consists mainly of cleaning the radio set, changing tubes, replacing

intermediate frequency and discriminator cans, and replacing the battery.

##### 34. Other Tools and Materials Required for Use with Equipment

*a. Tool Equipment TE-41.* The tools and materials contained in Tool Equipment TE-41 are listed in the Department of the Army Supply Manual SIG 6-TE-41.

*b. Solvent, Dry Cleaning (SD).* (Fed spec No. P-S-661a.) This is used for removal of dirt and corrosion.

#### Section II. PREVENTIVE MAINTENANCE SERVICES

##### 35. Definition of Preventive Maintenance

Preventive maintenance is work performed on equipment (usually when the equipment is not in use) to keep it in good working order so that breakdowns and needless interruptions in service will be kept to a minimum. Preventive maintenance differs from troubleshooting and repair in that its object is the prevention of troubles rather than their correction.

##### 36. General Preventive Maintenance Techniques

*a.* Use No. 000 sandpaper to remove corrosion.

*b.* Use a clean, dry, lint-free cloth or a dry brush for cleaning.

- (1) If necessary, except for electrical contacts, moisten the cloth or brush with solvent (SD); then wipe the parts dry with a cloth.
- (2) Clean electrical contacts with a cloth moistened with carbon tetrachloride; then wipe them dry with a dry cloth.

**Caution:** Repeated contact of carbon tetrachloride with the skin or prolonged breathing of the fumes is

dangerous. Make sure that adequate ventilation is provided. Do not use carbon tetrachloride on polyvinyl insulation. It is a solvent for this resin.

*c.* If available, dry compressed air may be used at a line pressure not exceeding 60 pounds per square inch to remove dust from inaccessible places; be careful however, or mechanical damage from the air blast may result.

*d.* For further information on preventive maintenance techniques, refer to TB SIG 178.

##### 37. Use of Preventive Maintenance Form (fig. 25)

*a.* The decision as to which items on DA Form 11-238 are applicable to this equipment is a tactical decision to be made in the case of first echelon maintenance by the communication officer/chief or his designated representative, and in the case of second and third echelon maintenance, by the individual making the inspection. Instructions for the use of the form appear on the reverse side of the form.

*b.* Circled items in figure 25 are partially or totally applicable to the radio set. References

**OPERATOR FIRST ECHELON MAINTENANCE CHECK LIST FOR SIGNAL CORPS EQUIPMENT**  
**RADIO COMMUNICATION, DIRECTION FINDING, CARRIER, RADAR**

*INSTRUCTIONS: See other side*

EQUIPMENT NOMENCLATURE **RADIO SETS AN/PRC-8, -8A, -9, -9A, -10, AND -10A.** EQUIPMENT SERIAL NO.

LEGEND FOR MARKING CONDITIONS: ✓ Satisfactory; X Adjustment, repair or replacement required; ⊗ Defect corrected.  
 NOTE: Strike out items not applicable.

**DAILY**

| NO. | ITEM  | CONDITION |   |   |   |   |   |   |
|-----|---|-----------|---|---|---|---|---|---|
|     |   | S         | M | T | W | T | F | S |
| ①   | COMPLETENESS AND GENERAL CONDITION OF EQUIPMENT (receiver, transmitter, carrying cases, wire and cable, microphones, tubes, spare parts, technical manuals and accessories). <b>PAR. 38 a</b> |           |   |   |   |   |   |   |
| ②   | LOCATION AND INSTALLATION SUITABLE FOR NORMAL OPERATION. <b>PAR. 38 b</b>   |           |   |   |   |   |   |   |
| ③   | CLEAN DIRT AND MOISTURE FROM ANTENNA, MICROPHONE, HEADSETS, CHESTSETS, KEYS, JACKS, PLUGS, TELEPHONES, CARRYING BAGS, COMPONENT PANELS. <b>PAR. 38 c</b>                                      |           |   |   |   |   |   |   |
| ④   | INSPECT SEATING OF READILY ACCESSIBLE "PLUCK-OUT" ITEMS: TUBES, LAMPS, CRYSTALS, FUSES, CONNECTORS, VIBRATORS, PLUG-IN COILS AND RESISTORS.   |           |   |   |   |   |   |   |
| ⑤   | INSPECT CONTROLS FOR BINDING, SCRAPING, EXCESSIVE LOOSENESS, WORN OR CHIPPED GEARS, MISALIGNMENT, POSITIVE ACTION. <b>PAR. 38 d</b>   |           |   |   |   |   |   |   |
| ⑥   | CHECK FOR NORMAL OPERATION. <b>PAR. 38 e</b>  |           |   |   |   |   |   |   |

**WEEKLY**

| NO. | ITEM   | CONDI-<br>TION | NO. | ITEM   | CONDI-<br>TION |
|-----|--|----------------|-----|--|----------------|
| ⑦   | CLEAN AND TIGHTEN EXTERIOR OF COMPONENTS AND CASES, RACK MOUNTS, SHOCK MOUNTS, ANTENNA MOUNTS, COAXIAL TRANSMISSION LINES, WAVE GUIDES, AND CABLE CONNECTIONS. <b>PAR. 38 f</b>                            |                | ⑬   | INSPECT STORAGE BATTERIES FOR DIRT, LOOSE TERMINALS, ELECTROLYTE LEVEL AND SPECIFIC GRAVITY, AND DAMAGED CASES. <b>PAR. 38 k</b> |                |
| ⑧   | INSPECT CASES, MOUNTINGS, ANTENNAS, TOWERS, AND EXPOSED METAL SURFACES, FOR RUST, CORROSION, AND MOISTURE. <b>PAR. 38 g</b>  |                | ⑭   | CLEAN AIR FILTERS, BRASS NAME PLATES, DIAL AND METER WINDOWS, JEWEL ASSEMBLIES. <b>PAR. 38 l</b>                                 |                |
| ⑨   | INSPECT CORD, CABLE, WIRE, AND SHOCK MOUNTS FOR CUTS, BREAKS, FRAYING, DETERIORATION, KINKS, AND STRAIN. <b>PAR. 38 h</b>  |                | ⑮   | INSPECT METERS FOR DAMAGED GLASS AND CASES.  |                |
| ⑩   | INSPECT ANTENNA FOR ECCENTRICITIES, CORROSION, LOOSE FIT, DAMAGED INSULATORS AND REFLECTORS. <b>PAR. 38 i</b>  |                | ⑯   | INSPECT SHELTERS AND COVERS FOR ADEQUACY OF WEATHER-PROOFING. <b>PAR. 38 m</b>   |                |
| ⑪   | INSPECT CANVAS ITEMS, LEATHER, AND CABLING FOR MILDEW, TEARS, AND FRAYING. <b>PAR. 38 j</b>  |                | ⑰   | CHECK ANTENNA GUY WIRES FOR LOOSENESS AND PROPER TENSION.  |                |
| 12  | INSPECT FOR LOOSENESS OF ACCESSIBLE ITEMS: SWITCHES, KNOBS, JACKS, CONNECTORS, ELECTRICAL TRANSFORMERS, POWER-STATS, RELAYS, SELSYNS, MOTORS, BLOWERS, CAPACITORS, GENERATORS, AND PILOT LIGHT ASSEMBLIES. |                | 18  | CHECK TERMINAL BOX COVERS FOR CRACKS, LEAKS, DAMAGED GASKETS, DIRT AND GREASE.   |                |
| ⑰   | IF DEFICIENCIES NOTED ARE NOT CORRECTED DURING INSPECTION, INDICATE ACTION TAKEN FOR CORRECTION. <b>PAR. 38 n</b>  |                |     |  |                |

**DA FORM 11-238**  
 1 MAY 51

REPLACES DA AGO FORM 419, 1 DEC 50, WHICH IS OBSOLETE.

TM612-10

Figure 25. DA Form 11-238.



in the ITEM block are to paragraphs in text which contain additional maintenance information.

### 38. Performing Preventive Maintenance

**Caution:** Tighten screws, bolts, and nuts carefully. Fittings tightened beyond the pressure for which they are designed may be damaged or broken.

a. Check for completeness of equipment, spare parts, technical manuals, and accessories (par. 7).

b. Check for suitable location and correct installation of the radio set. If possible, avoid placing the radio set in a muddy or wet location.

c. Remove dirt and moisture from the antenna, handset, and connectors (fig. 2).

d. Inspect TUNING control, VOL control, SQUELCH control, and POWER switch (fig. 6) for binding, scraping, excessive looseness, and for positive action.

e. Check for normal operation; refer to equipment performance check list (par. 48).

f. Clean the radio set, including antenna mount and cable connections.

g. Inspect the cases, antenna, and all exposed metal surfaces for rust, corrosion, and moisture (fig. 2).

h. Inspect the handset cable for cuts, breaks, fraying, deterioration, kinks, and strain.

i. Inspect the antenna for eccentricities, corrosion, loose fit, and damaged insulators.

j. Inspect canvas items and cables for mildew, tears, and fraying.

k. When the radio set is used in a vehicle and is powered by Amplifier-Power Supply AM-598/U, inspect the vehicular storage battery for dirt, loose terminals, electrolyte level, specific gravity, and for damage to the battery case.

l. Clean the dial window (fig. 6).

m. Inspect shelters and covers for adequacy of weatherproofing.

n. If deficiencies noted are not corrected during inspection, indicate action needed for correction.

### 39. Unreliability of Oscillator Tube Type 1AD4 in Radio Sets AN/PRC-8 and -10

a. *Tube Failure.* An undetermined quantity of tubes type 1AD4, have a minimum lifetime of 10 hours when used as the receiver oscillator (V8) in Radio Sets AN/PRC-8 and AN/PRC-10. These tubes are in lot numbers 202 through 226. Failure of this tube is evidenced by a sound resembling motorboating. This type of failure will not be indicated on a tube tester.

b. *Replacement.* If oscillation of this type occurs, remove the original tube and replace it with a new tube (Sig C stock No. 2J1AD4). When replacing this tube, be sure that the red dot on the tube corresponds to the pimple on the socket.

### 40. Correction of Faulty Battery Socket

*Note.* The procedures below apply to Battery BA-279/U procured on Orders No. 16613-Phila-51, 16517-Phila-51, 14453-Phila-51, and 15609-Phila-51.

a. *Reason for Failure of Radio Set.* Reports have indicated operational failure of the radio set because of intermittent or poor contact between battery plug P1 and the socket of Battery BA-279/U. The following factors are primarily responsible for such difficulties.

- (1) The jacket socket opening is too small to allow the battery plug to be seated properly in the socket.
- (2) The battery socket has sufficient give under pressure to prevent proper mating because of inadequate support in the socket well.

b. *Corrective Action in Field.* Apply either of the following measures immediately prior to installation:

- (1) Cut away the top of the battery jacket at the socket end with a knife.
- (2) Increase the size of the jacket socket opening to at least  $1\frac{3}{8}$  inches in diameter by trimming away a portion of the edge of the jacket socket opening.

### Section III. LUBRICATION

#### 41. Lubrication of Dial-drive Mechanism

Under normal conditions, it is expected that the dial-drive mechanism will not require lubrication. If, however, there is corrosion or dirt on the gears, cleaning and lubrication will be necessary. This requires removal of the control panel from the chassis of the receiver-transmitter. Instructions for this procedure are contained in TM 11-4065 and are to be performed only by authorized personnel.

#### 42. Lubrication under Unusual Conditions

The effects of extreme cold and heat on materials and lubricants are explained in TB SIG 69; observe all precautions.

*a. Arctic Regions.* Under conditions of extreme cold such as those existing in arctic regions, grease will solidify and prevent operation of the gears of the dial-drive mechanism. For arctic operation, therefore, all grease must be removed from the dial-drive mechanism. Authorized personnel will remove the control panel from the chassis of the receiver-transmitter as described in TM 11-4065 and remove all grease from the dial-drive mechanism.

*b. Desert Regions.* Dust and sand infiltration into the radio set causes grit in the lubricants and will seriously damage the radio set. Use lubricants suitable for high temperatures. Inspect the radio set daily and clean it whenever necessary.

### Section IV. WEATHERPROOFING

#### 43. Weatherproofing

*a. General.* Signal Corps equipment, when operated under severe climatic conditions such as those prevailing in tropical, arctic, and desert regions, requires special treatment and maintenance. Fungus growth, insects, dust, corrosion, salt spray, excessive moisture, and extreme temperatures are harmful to most materials.

*b. Tropical Maintenance.* A special moisture-proofing and fungiproofing treatment has been devised which, if properly applied, provides a reasonable degree of protection. This treatment is explained in TB SIG 13 and TB SIG 72.

*c. Arctic Maintenance.* Special precautions necessary to prevent poor performance or total operational failure of equipment in extremely low temperatures are explained in TB SIG 66 and TB SIG 219.

*d. Desert Maintenance.* Special precautions necessary to prevent equipment failure in areas subject to extremely high temperatures, low

humidity, and excessive sand and dust are explained in TB SIG 75.

#### 44. Rustproofing and Painting

*a.* When the finish on the case has been badly scarred or damaged, rust and corrosion can be prevented by touching up bared surfaces. Use No. 00 or No. 000 sandpaper to clean the surface down to the bare metal; obtain a bright smooth finish.

**Caution:** Do not use steel wool. Small particles frequently enter the case and cause harmful internal shorting or grounding of circuits.

*b.* When a touch-up job is necessary, apply paint with a small brush. Remove rust from the case by cleaning corroded metal with solvent (SD). In severe cases it may be necessary to use solvent (SD) to soften the rust and sandpaper to complete the preparation for painting. Paint used will be authorized and consistent with existing regulations. For further information on painting equipment, refer to TM 9-2851.

### Section V. TROUBLESHOOTING AT ORGANIZATIONAL MAINTENANCE LEVEL

*Note.* Troubleshooting information for field maintenance personnel is contained in TM 11-4065.

#### 45. General

*a.* The troubleshooting and repair work that can be performed at the organizational main-

tenance level (operators and repairmen) is necessarily limited in scope by the tools, test equipment, and replaceable parts issued, and by the existing tactical situation. Accordingly, troubleshooting is based on the performance of

the equipment and the use of the senses in determining such troubles as burned-out tubes, burned or broken resistors, etc.

*b.* The following paragraphs help in determining which of the components, such as the receiver section or transmitter section, is at fault, and in localizing the fault in that component to the defective stage or item, such as a tube or plug-in stage.

#### 46. Inspection

*a.* When failure is encountered and the cause is not immediately apparent, check as many of the items in *b* below as is practicable before starting a detailed examination of the component parts of the system. If possible, obtain information from the operator of the equipment regarding performance at the time trouble occurred.

*b.* Failure of this equipment to operate properly usually will be caused by one or more of the following faults:

- (1) Cable improperly plugged into power source.
- (2) Faulty power source.
- (3) Worn, broken, or disconnected cords and plugs.
- (4) Relay contacts burned because of overloads.
- (5) Wires or solder joints broken because of excessive vibration.
- (6) Defective tubes.
- (7) Inactive crystals.

#### 47. Instructions for Using Equipment Performance Check List

*a. General.* The equipment performance

check list (par. 48) will help the operator to locate trouble in the equipment. The list contains the items to be checked, the conditions under which the item is checked, the normal indications and tolerances of correct operations, and the corrective measures the operator can take. When using this list, perform the checks in the sequence indicated in the list.

*b. Action or Condition.* For some items, the information given in the action or condition column consists of various switch and control settings under which the item is to be checked. For other items it represents an action that must be taken to check the normal indication given in the normal indications column.

*c. Normal Indications.* The normal indications listed include the visible and audible signs that the operator should perceive when he checks the items. If the indications are not normal, the operator should apply the recommended corrective measures.

*d. Corrective Measures.* The corrective measures listed are those the operator can make without returning the equipment for repairs. If the set is completely inoperative or if the recommended corrective measures do not yield results, higher echelon maintenance will be necessary (refer to TM 11-4065). However, if the tactical situation requires that communication be maintained, and if the set is not completely inoperative, the operator must maintain the set in operation as long as possible. For location of components, refer to figures 26 and 27 for the unlettered models, and to figures 28 and 29 for the A models of the receiver-transmitter.

#### 48. Equipment Performance Check List

|             | Item No. | Item                | Action or condition  | Normal indications | Corrective measures |
|-------------|----------|---------------------|--|--------------------|---------------------|
| PREPARATORY | 1        | Battery BA-279/U... | Install in battery case (par. 15 <i>a</i> ).                     |                    |                     |
|             | 2        | Antenna.....        | Install in proper antenna jack (par. 15 <i>b</i> and <i>c</i> ). |                    |                     |
|             | 3        | Handset.....        | Plug into AUDIO connector.                                       |                    |                     |
|             | 4        | SQUELCH control...  | Set to OFF.  |                    |                     |
|             | 5        | VOL control.....    | Set to 10.   |                    |                     |
|             | 6        | TUNING control....  | Set to desired operating frequency.                              |                    |                     |

|                       | Item No. | Item                         | Action or condition   | Normal indications  | Corrective measures   |
|-----------------------|----------|------------------------------|---|---|---|
| START                 | 7        | POWER switch-----            | Hold at CAL & DIAL LITE.  | Dial light lights.<br><br>Rushing noise is heard in handset receiver.   | Replace lamp E8. Check for correct battery voltages with Battery Tester TS-183/U (fig. 30). If voltages are low, replace battery.<br>Replace battery. One at a time, replace receiver tubes V4, V5, V6, V7, and V8, if and discriminator cans U101, U102, U103, U104, U105, and T201. (There is no U105 in Radio Sets AN/PRC-8A, -9A, and -10A.) Remove squelch tube V11; if no noise is heard, replace V11. Check squelch relay K2 for sticking (if the relay is not a sealed type). |
|                       | 8        | DIAL LOCK-----               | Turn counterclockwise.  | Unlock TUNING control.  |   |
| EQUIPMENT PERFORMANCE | 9        | TUNING control-----          | Tune from extreme low end of dial to extreme high end of dial. (POWER switch at CAL & DIAL LITE.) | Whistle heard in phone of handset at all calibration points. (Calibration points of Radio Sets AN/PRC-8, -9, and -10 are at each whole number mc point on dial, calibration points of Radio Sets AN/PRC-8A, -9A, and -10A are at intervals of 2.15 mc.)<br>Whistle heard at all whole number mc points shows receiver operating over entire band. | Replace calibrator tubes V9 and V10, one at a time. (There is no V10 in Radio Sets AN/PRC-8A, -9A, and -10A.)<br><br>Change receiver oscillator tube V8.  |
|                       | 10       | POWER SWITCH-----            | Release to ON.  | DIAL LITE out. Rushing noise can be heard in handset.   | Check POWER switch.   |
|                       | 11       | TUNING control-----          | Tune in other equipment that is transmitting.<br>Turn DIAL LOCK clockwise to end of travel.       | Voice signals are heard.<br><br>Locks TUNING.   | Check antenna and antenna connections.<br><br>Mechanically readjust DIAL LOCK.  |
|                       | 12       | SQUELCH control-----         | With no signal being received, adjust to point where noise just disappears.                       | No noise in handset receiver when no signal is being received. Signal can be tuned in as in item 11.  | Change squelch tube V11. Check switch on SQUELCH control.   |
|                       | 13       | Handset push-to-talk button. | Press button and talk into handset microphone.  | Rushing noise stops; signal is picked up by receiver tuned to transmitter frequency.  | Replace handset. In Radio Sets AN/PRC-8, -9, and -10, replace V1, V2, and V3 (one at a time). In Radio Sets AN/PRC-8A, -9A, and -10A, replace V2, V3 and U301. Check relay K1 for sticking (if the relay is not a sealed type).   |

|                | Item No. | Item   | Action or condition   | Normal indications  | Corrective measures  |
|----------------|----------|--|---|---|--|
| REMOTE CONTROL | 14       | POWER switch.....<br><br>SET 1 (or SET 2) cable of Local Control C-434/GRC (auxiliary equipment).<br><br>REMOTE switch of Local Control C-434/GRC. | Set at REMOTE<br><br>Connect to AUDIO connector of radio set. Connect handset to AUDIO connector of Local Control C-434/GRC.<br><br>Set at SET 1 & 2. | No power is applied to radio set.<br><br>Power is turned on in radio set. This is indicated by rushing noise in handset receiver. | Check POWER switch.<br><br>Replace remote control unit; check wiring inside radio set to AUDIO connector (see TM 11-4065). |
|                | STOP     | 15   | POWER switch.....   | Turn to OFF. (Remove battery from case if radio set will not be operated within 24 hours.)  | Power is turned off.   |

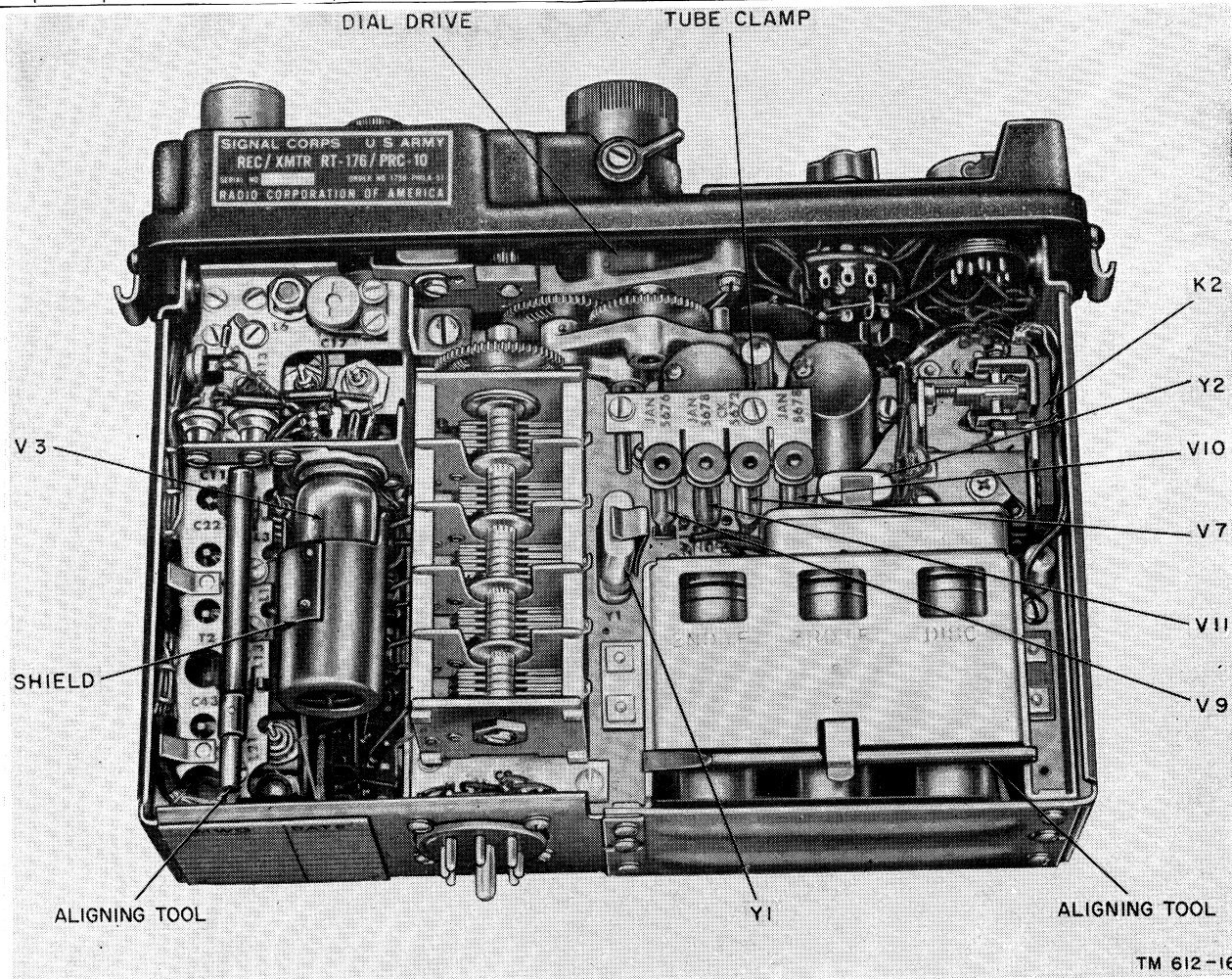

Figure 26. Receiver-transmitter chassis (unlettered models), bottom view.

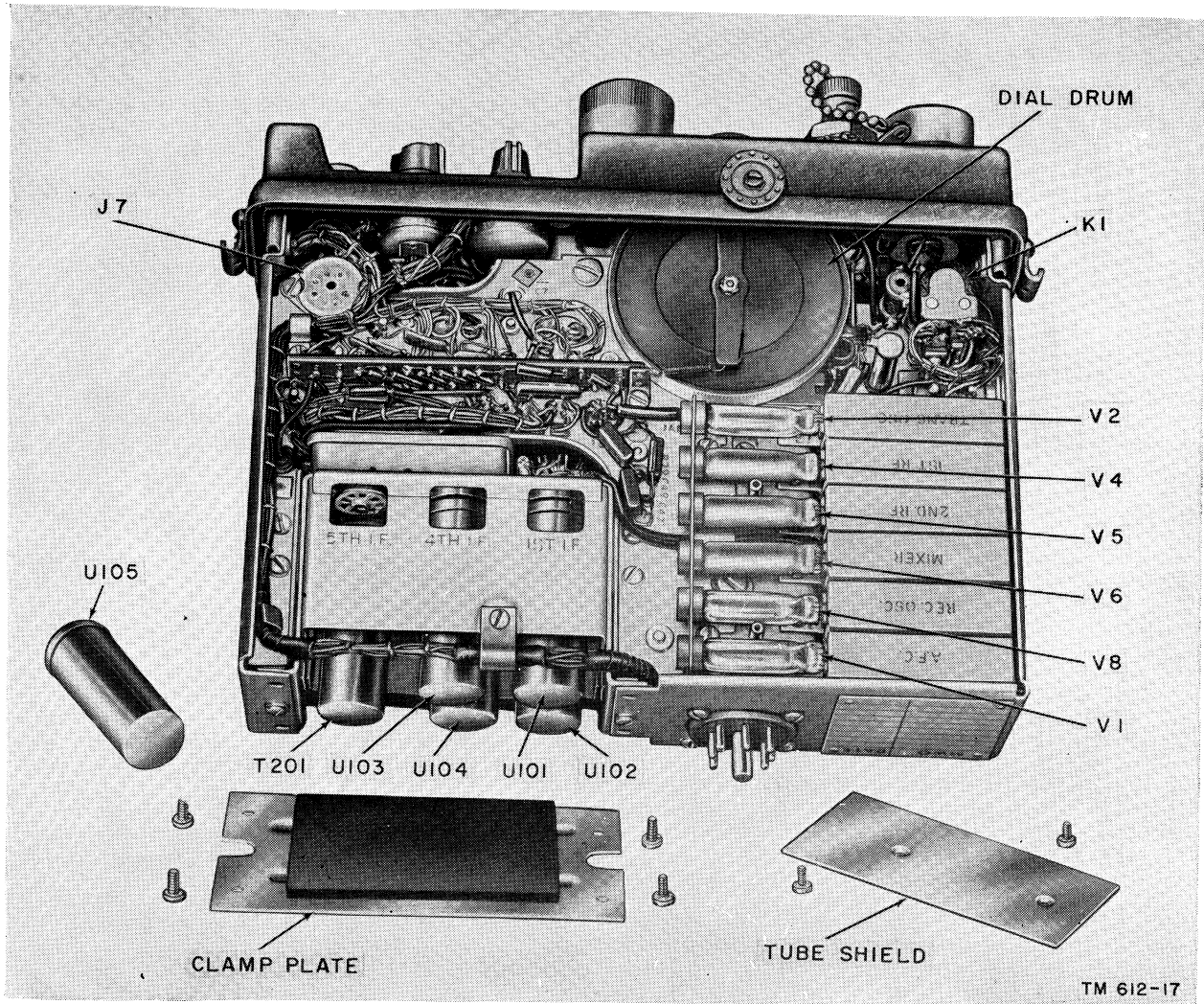

Figure 27. Receiver-transmitter chassis (unlettered models), top view.

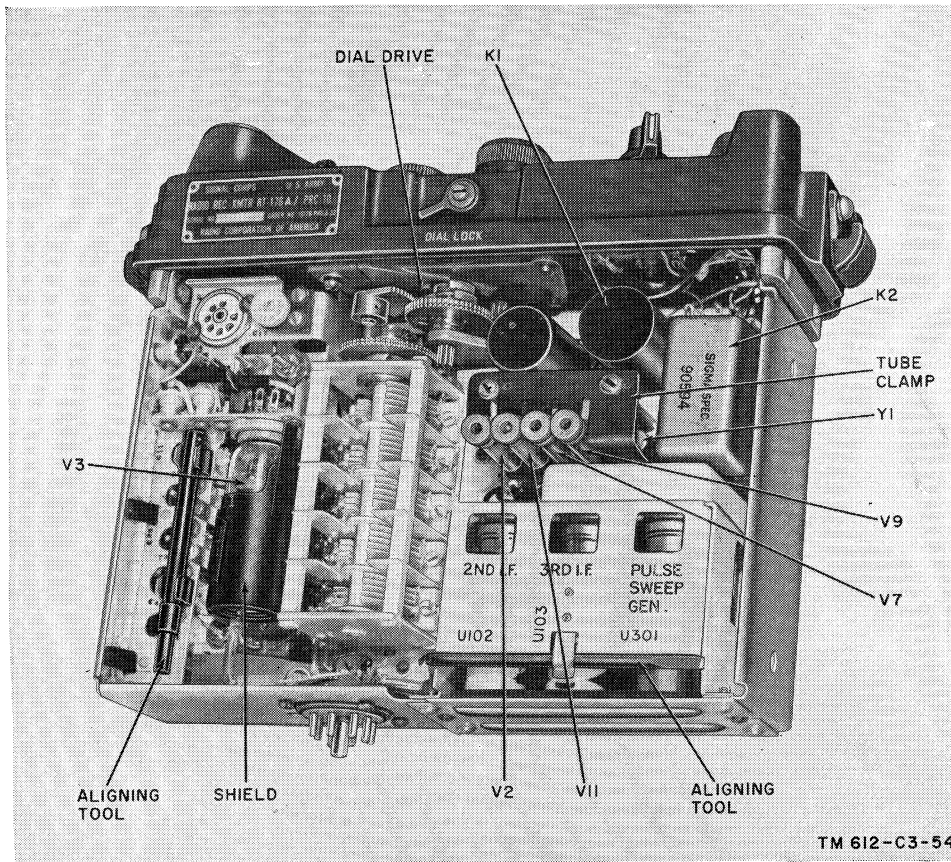

Figure 28. Receiver-transmitter chassis (A models), bottom view.

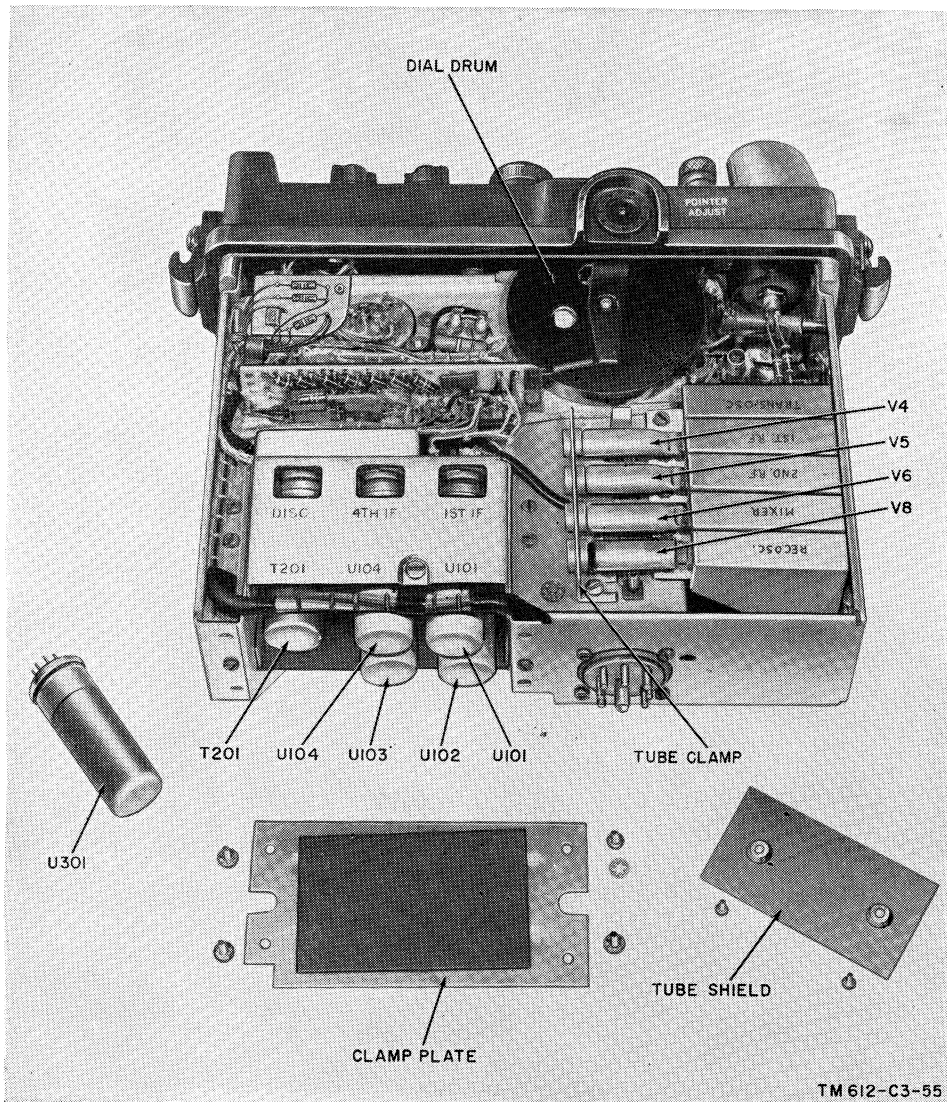
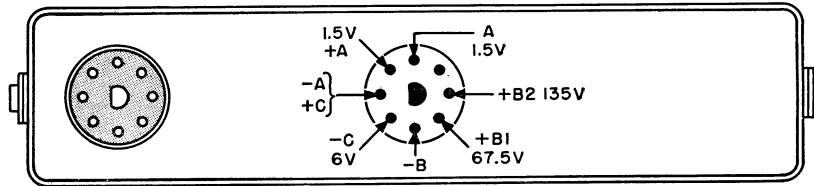

Figure 29. Receiver-transmitter chassis (A models), top view.





BATTERY BA-279/U

TEST WITH TS-183/U

| TO TEST UNIT | USE JACK NO. | READ VOLTAGE      |
|--------------|--------------|-------------------|
| -A TO +A     | 1            | (MINIMUM)<br>1.35 |
| -B TO +B1    | 23           | 60.00             |
| +B1 TO +B2   | 27           | 60.00             |
| -C TO +C     | 6            | 5.00              |

TM612-15

Figure 30. Battery BA-279/U, socket and test chart.

## CHAPTER 5

### DESCRIPTION OF AUXILIARY EQUIPMENT

#### 49. Amplifier-Power Supply AM-598/U

Amplifier-Power Supply AM-598/U (fig. 31) is a vibrator type power supply that is used with the radio set for vehicular operation. The power supply, which operates from a 24-volt direct current (dc) source, supplies the power requirements of the radio set, and also contains an audio amplifier for operation of a loudspeaker (Dynamic Loudspeaker LS-166/U). For detailed information on the power supply, refer to TM 11-5055.

#### 50. Control Group AN/GRA-6

a. Control Group AN/GRA-6 (fig. 32) may be used to control a radio set from a position as far as 5 miles away. It also provides for telephone communication (including ringing) between the local and remote control stations. Control Group AN/GRA-6 consists of Local Control C-434/GRC, Remote Control C-433/

GRC, Handset H-33(\*)/PT, and Bag CW-189/GR. The local and remote control units are connected by a pair of telephone wires (such as Wire WD-1/TT) which is supplied separately.

b. Local Control C-434/GRC may be connected directly to the panels of one or two radio sets by means of the plug-terminated cords at the rear of the unit (fig. 18). The switching facilities of the unit permit transmission and reception over either or both sets from a handset plugged into the AUDIO connector on the front panel.

c. Remote Control C-433/GRC may be used as far as 5 miles from the local control unit. The combined switching actions of the local and remote control units make it possible to extend both power control and push-to-talk control to the remote unit. The remote unit also accommodates a handset.

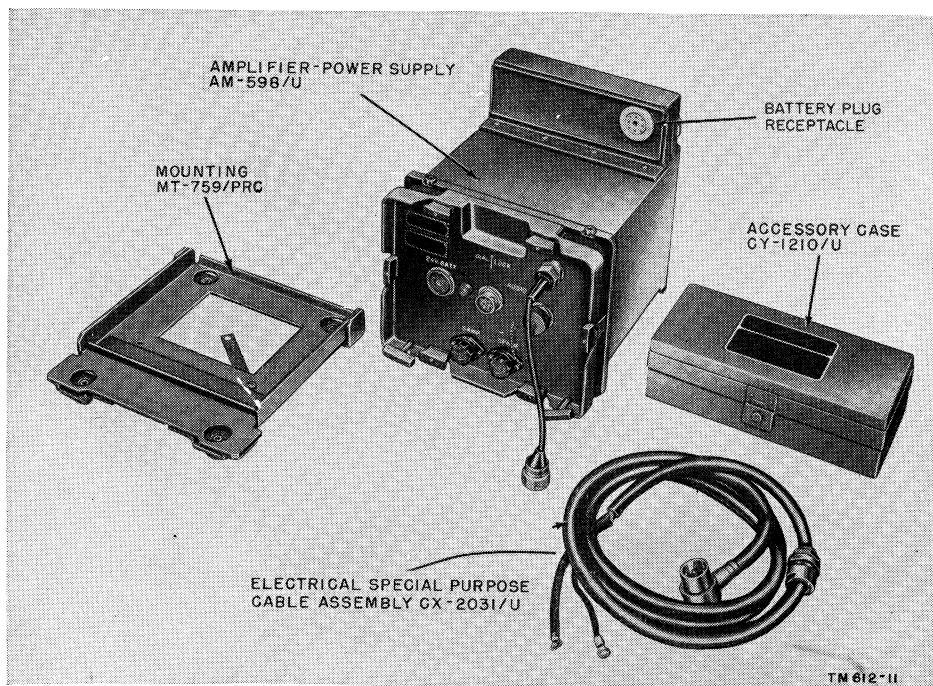
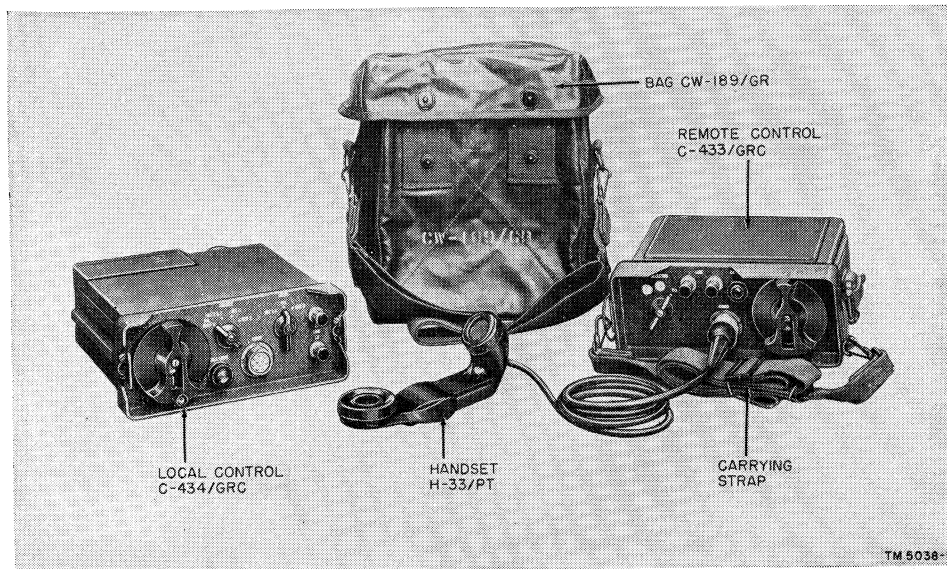

Figure 31. Amplifier-power supply AM-598/U.



*Figure 32. Control group AN/GRA-6.*

*d.* Handset H-33(\*)/PT is used at the panel AUDIO connector of each control unit. The handset is equipped with a push-to-talk button.

*e.* Bag CW-189/GR is a dustproof and waterproof carrying bag which is large enough to hold the two control units and the handset when not in use. It is equipped with a carrying strap.

*f.* For detailed information on Control Group AN/GRA-6, refer to TM 11-5038.

#### 51. Homing Antennas AT-339/PRC and AT-340/PRC, and Antenna AT-249/GRD

Three homing antennas may be used with the radio set. Homing Antenna AT-340/PRC covers the frequency range from 20 to 38 mc.

Homing Antenna AT-339/PRC covers the frequency range from 38 to 54.9 mc. Antenna AT-249/GRD covers the frequency range from 47 to 55.4 mc. These antennas are loop antennas and are all similar to the one shown on figure 24.

#### 52. Antenna Equipment RC-292

Antenna Equipment RC-292 (fig. 33) is an elevated, wide-band, modified ground-plane antenna that can be used as an auxiliary antenna with the radio set to increase the distance range. The antenna is elevated on a 30-foot mast which is held erect by guy ropes and ground stakes. Complete instructions for the antenna are contained in TM 11-5020.

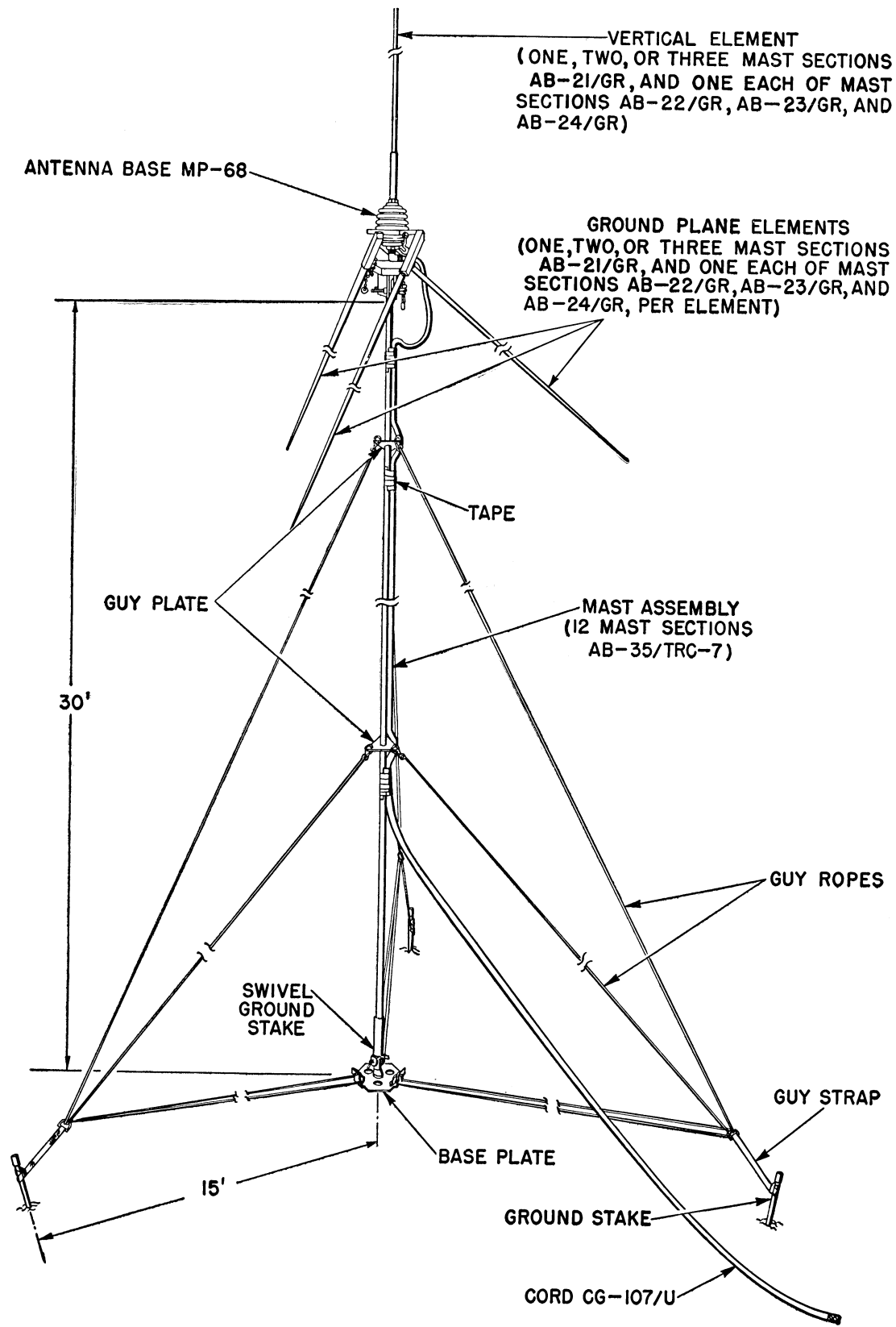

TM 612-214

Figure 33. Antenna equipment RC-292.

## CHAPTER 6

### DEMOLITION OF MATERIEL TO PREVENT ENEMY USE

---

#### 53. Authority for Demolition

Demolition of the equipment will be accomplished only upon the order of the commander. The demolition procedures outlined in paragraph 54 will be used to prevent the enemy from using or salvaging the equipment.

#### 54. Methods of Destruction

*a. Smash.* Smash the crystals, handset, tubes, coils, switches, batteries, capacitors, cases, and transformers; use sledges, axes, handaxes, pickaxes, hammers, crowbars, or heavy tools.

*b. Cut.* Cut cords, pouch, suspenders, and wiring; use axes, handaxes, or machetes.

*c. Burn.* Burn cords, resistors, capacitors, coils, wiring, and technical manuals; use gasoline, kerosene, oil, flame throwers, or incendiary grenades.

*d. Bend.* Bend panels, cases, and chassis.

*e. Explosives.* If explosives are necessary, use firearms, grenades, or TNT.

*f. Disposal.* Bury or scatter the destroyed parts in slit trenches, fox holes, or throw them into streams.

*g. Destroy.* Destroy everything.

# INDEX

|   | <i>Paragraph</i> | <i>Page</i> |  | <i>Paragraph</i> | <i>Page</i> |
|---|------------------|-------------|--|------------------|-------------|
| <b>Antennas:</b>  |                  |             | <b>Description—Continued</b>                   |                  |             |
| Antenna Equipment RC-292.....                                   | 20, 52           | 18, 41      | Equipment characteristics.....                 | 4                | 3           |
| Homing antennas:  |                  |             | Homing Antennas AT-339/PRC and AT-340/PRC..... | 11, 51           | 10, 41      |
| Connection.....   | 19               | 17          | Minor components.....                          | 10               | 7           |
| Description.....  | 51               | 41          | Packaging data.....                            | 6                | 4           |
| Operation.....  | 28               | 26          | Radio set.....                                 | 8                | 7           |
| <b>Antijamming</b> .....  | 25               | 24          | Receiver-transmitter.....                      | 9                | 7           |
| <b>Auxiliary equipment:</b>                                     |                  |             | Destruction, methods.....                      | 54               | 43          |
| Amplifier-power supply AM-598/U:                                |                  |             | Differences in models.....                     | 12               | 10          |
| Description.....  | 49               | 40          | Equipment performance check list.....          | 47, 48           | 33          |
| Installation.....   | 16               | 15          | Forms and records.....                         | 2                | 3           |
| Operation.....  | 24               | 24          | Frequency calibration and tuning.....          | 23               | 22          |
| Antenna Equipment RC-292:                                       |                  |             | Homing antennas:                               |                  |             |
| Connection.....   | 20               | 18          | Connection.....                                | 19               | 17          |
| Description.....  | 52               | 41          | Description.....                               | 51               | 41          |
| Control Group AN/GRA-6:   |                  |             | Operation.....                                 | 28               | 26          |
| Description.....  | 50               | 40          | Inspection.....                                | 46               | 33          |
| Installation.....   | 17               | 17          | Installation:                                  |                  |             |
| Operation.....  | 27               | 25          | Amplifier-Power Supply AM-598/U.....           | 20               | 18          |
| Homing Antennas AT-339/PRC, AT-340/PRC, and Antenna AT-249/GRD: |                  |             | Antenna Equipment RC-292.....                  | 16               | 15          |
| Connection.....   | 19               | 17          | Battery BA-279/U.....                          | 15               | 14          |
| Description.....  | 51               | 41          | Control Group AN/GRA-6.....                    | 17               | 17          |
| Operation.....  | 28               | 26          | Homing antennas.....                           | 19               | 17          |
| <b>Battery installation</b> .....                               | 15               | 14          | Man-pack operation.....                        | 15               | 14          |
| <b>Calibration, frequency</b> .....                             | 23               | 22          | Relay operation.....                           | 18               | 17          |
| <b>Characteristics, equipment</b> .....                         | 4                | 3           | Remote control operation.....                  | 17               | 17          |
| <b>Check list, equipment performance</b> .....                  | 47, 48           | 33          | Vehicular operation.....                       | 16               | 15          |
| <b>Components, list</b> .....                                   | 7                | 4           | List of components.....                        | 7                | 4           |
| <b>Connections:</b>   |                  |             | Lubrication:                                   |                  |             |
| Antenna Equipment RC-292.....                                   | 20               | 18          | Dial-drive mechanism.....                      | 41               | 32          |
| Control Group AN/GRA-6.....                                     | 17               | 17          | Unusual conditions, under.....                 | 42               | 32          |
| Homing antennas.....  | 19               | 17          | Nomenclature assignments.....                  | 5                | 4           |
| Man-pack operation.....   | 15               | 14          | <b>Operation:</b>                              |                  |             |
| Relay operation.....  | 18               | 17          | Antijamming.....                               | 25               | 24          |
| Remote control operation.....                                   | 17               | 17          | Arctic climates.....                           | 30               | 28          |
| Vehicular operation.....  | 16               | 15          | Basic.....                                     | 24               | 24          |
| <b>Control Group AN/GRA-6:</b>                                  |                  |             | Desert climates.....                           | 32               | 28          |
| Description.....  | 11, 50           | 10, 40      | Homing.....                                    | 28               | 26          |
| Installation.....   | 17               | 17          | Relay.....                                     | 26               | 24          |
| Operation.....  | 27               | 25          | Remote control.....                            | 27               | 25          |
| <b>Controls and their use</b> .....                             | 22               | 22          | Tropical climates.....                         | 31               | 28          |
| <b>Correction of faulty battery socket</b> .....                | 40               | 31          | Packaging data.....                            | 6                | 4           |
| <b>Demolition</b> .....   | 53, 54           | 43          | Painting.....                                  | 44               | 32          |
| <b>Description:</b>   |                  |             | Preparation for operation.....                 | 13-23            | 12-22       |
| Antenna AT-249/GRD.....   | 11, 51           | 10, 41      | Preventive maintenance:                        |                  |             |
| Antenna Equipment RC-292.....                                   | 11, 52           | 10, 41      | Definition.....                                | 35               | 29          |
| Auxiliary equipment.....  | 11, 49-52        | 10, 40      | Form, use.....                                 | 37               | 29          |
| Control Group AN/GRA-6.....                                     | 50               | 40          |  |                  |             |

|                                   | <i>Paragraph</i> | <i>Page</i> |   | <i>Paragraph</i> | <i>Page</i> |
|-----------------------------------|------------------|-------------|---|------------------|-------------|
| Preventive maintenance—Continued  |                  |             | Troubleshooting:  |                  |             |
| Performing-----                   | 38               | 31          | Equipment performance check list---                     | 47,48            | 33          |
| Techniques, general-----          | 36               | 29          | Inspection-----   | 46               | 33          |
| Purpose and use-----              | 3                | 3           | Tuning-----   | 23               | 22          |
| Relay operation-----              | 26               | 24          | Uncrating, unpacking, and checking new<br>equipment.    | 14               | 12          |
| Relay operation, connections----- | 18               | 17          | Unreliability, oscillator V8-----                       | 39               | 31          |
| Remote control:                   |                  |             | Used or reconditioned equipment, service<br>on receipt. | 21               | 21          |
| Installation-----                 | 17               | 17          |   |                  |             |
| Operation-----                    | 27               | 25          | Vehicular installation-----                             | 16               | 15          |
| Rustproofing-----                 | 44               | 32          | Weatherproofing-----                                    | 43               | 32          |
| Siting-----                       | 13               | 12          |   |                  |             |
| Tools and materials-----          | 33, 34           | 29          |   |                  |             |

[AG 413.44 (6 Dec 54)]

BY ORDER OF THE SECRETARIES OF THE ARMY AND THE AIR FORCE:

M. B. RIDGWAY,  
*General, United States Army,*  
*Chief of Staff.*

OFFICIAL:

JOHN A. KLEIN,  
*Major General, United States Army,*  
*The Adjutant General.*

N. F. TWINING,  
*Chief of Staff, United States Air Force.*

OFFICIAL:

E. E. TORO,  
*Colonel, United States Air Force,*  
*Air Adjutant General.*

DISTRIBUTION:

*Active Army:*

Tec Svc, DA (1)  
Tec Svc Bd (1)  
AFF (5)  
AFF Bd (incl ea Test Sec) (1)  
Army AA Comd (2)  
OS Maj Comd (5)  
OS Base Comd (5)  
Log Comd (5)  
MDW (1)  
Armies (5)  
Corps (2)  
Tng Div (2)  
Ft & Cp (2)  
Gen & Br Svc Sch (5)  
SigC Sch (25)  
Gen Depots (2)  
SigC Sec, Gen Depots (10)  
SigC Depots (20)  
POE (2)  
OS Sup Agencies (2)  
SigC Fld Maint Shops (3)  
SigC Lab (5)  
Mil Dist (1)

Units organized under the following TOE:

3-267A, Cml Smoke Genr Co (2)  
5-15, Engr Cmbt Bn Div (2)  
5-16, H&S Co Engr Cmbt Bn Div (2)  
5-17, Engr Cmbt Co Div (2)  
5-35A, Engr Cmbt Bn-A (2)  
5-36A, H&S Co Engr Cmbt Bn-A (2)  
5-37A, Engr Cmbt Co-A (2)  
5-138A, Engr Float Bridge Co (2)  
5-139A, Engr Pontoon Bridge Co (2)  
5-192A, Hq&Hq Co, Engr Cmbt Gp (2)  
5-215, Armd Engr Bn (2)  
5-216, H&S Co, Armd Engr Bn (2)  
5-225A, Abn Engr Bn (2)  
5-226A, H&S Co, Abn Engr Bn (2)  
5-227A, Abn Engr Co, Abn Engr Bn (2)  
5-346A, Hq&Hq Det, Engr B Topo Bn (2)  
5-348A, Engr B Survey Co (2)  
5-367A, Engr Lt Eqp Co (2)  
5-415A, Engr Avn Bn (2)  
5-416A, H&S Co, Engr Avn Bn (2)  
5-417A, Engr Avn Co, Engr Avn Bn (2)  
5-525A, Engr Shore Bn (2)  
5-526A, H&S Co, Engr Shore Bn (2)

5-527A, Engr Shore Co (2)  
 6-100A, Div Arty, Inf Div (2)  
 6-101A, Hq&Hq Btry, Arty-Inf Div (2)  
 6-115A, FA Bn (75mm How Pack) (2)  
 6-116A, H&S Btry, FA Bn (75mm How, Pack) (2)  
 6-117A, FA Btry (75mm How, Pack) (2)  
 6-125A, FA Bn (105mm How, Towed) (2)  
 6-126, Hq&Hq Btry, FA Bn (105mm How, Towed) (2)  
 6-127, FA Btry (105mm How, Towed) (2)  
 6-135, FA Bn (155mm How, Towed) (2)  
 6-136, Hq&Hq Btry, FA Bn (155mm How, Towed) (2)  
 6-137, FA Btry (155mm How, Towed) (2)  
 6-200A, Div Arty, Abn Div (2)  
 6-201A, Hq&Hq Btry, Div Arty, Abn Div (2)  
 6-225A, Abn FA Bn (105mm How, Towed) (2)  
 6-226A, Hq&Hq Btry, Abn FA Bn (105mm How, Towed) (2)  
 6-227A, Abn FA Btry (105mm How, Towed) (2)  
 6-235A, Abn FA Bn (155mm How, Towed) (2)  
 6-236A, Hq&Hq Btry, Abn FA Bn (155mm How, Towed) (2)  
 6-237A, Abn FA Btry (155mm How, Towed), (2)  
 6-300, Div Arty, Armd Div (2)  
 6-301A, Hq&Hq Btry, Div Arty Armd Div (2)  
 6-315, FA Bn (105mm How, SP Armd) (2)  
 6-316, Hq&Hq Btry, Armd FA Bn (105mm How, Sp, Div) (2)  
 6-317, FA Btry (105mm How, SP Armd) (2)  
 6-325, FA Bn (155mm How, SP Armd) (2)  
 6-326, Hq&Hq Btry, FA Bn (155mm How, SP Armd) (2)  
 6-327, FA Btry (155mm How, SP, Armd) (2)  
 6-401, Hq&Hq Btry, FA Gp (2)  
 6-415A, FA Bn (Hv Towed 155mm How 8 Inch) (2)  
 6-416A, Hq&Hq Btry, FA Bn (Hv Towed or SP) (2)  
 6-435A, FA Bn Hv Sp (155mm-8 Inch How) (2)  
 6-501A, Hq&Hq Btry, Cor Arty or Abn Cor Arty (2)  
 6-515A, FA Bn (Very Hv Towed 240mm How) (2)  
 6-535A, FA Bn (28mm Gun) (2)  
 6-536A, H&S Btry, FA Bn (280mm Gun) (2)  
 6-537A, FA Btry (280mm Gun) (2)  
 6-538A, FA Rkt Btry (762mm) (2)  
 6-545A, FA Msl Bn, Cpl (2)  
 6-547A, FA Msl Btry, Cpl (2)  
 6-558A, FA Slt Btry (2)  
 6-575, FA Obsr Bn (2)  
 6-576, Hq&Hq Btry, FA Obsr Bn (2)  
 6-577, FA Obsr Btry (2)  
 7A, Inf Div (2)  
 7-1, Hq, Inf Div (2)  
 7-2, Hq Co, Inf Div (2)  
 7-11, Inf Regt (2)  
 7-12, Hq&Hq Co, Inf Regt (2)  
 7-14, Inf Hv Mort Co. (2)  
 7-15, Inf Bn (2)  
 7-16, Hq&Hq Co, Inf Bn (2)  
 7-17, Inf R Co (2)  
 7-18, Inf Hv Wpn Co (2)  
 7-25, Armd Inf Bn (2)  
 7-26, H&S Co, Armd Inf Bn (2)  
 7-27, R Co, Armd Inf Bn (2)  
 7-31, Abn Inf Regt (2)  
 7-32A, Hq&Hq Co, Abn Inf Regt (2)  
 7-34A, Spt Co, Abn Inf Regt (2)  
 7-35A, Abn Inf Bn (2)  
 7-36A, Hq&Hq Co, Abn Inf Bn (2)  
 7-37A, Abn Inf R Co (2)  
 7-38A, Abn Inf Hv Wpn Co (2)  
 7-45, Inf Hv Mort Bn (2)  
 7-47, Inf Mort Co (Hv), Mort Bn (2)  
 7-95A, Inf Bn, Sep (2)  
 7-96A, H&S Co, Inf Bn, Sep (2)  
 8-7, Med Co, Inf Regt (2)  
 8-37A, Med Co, Abn Inf Regt (2)  
 8-75, Armd Med Bn (2)  
 8-76, Hq&Hq Co, Armd Med Bn (2)  
 11-7, Sig Co Inf Div (2)  
 11-15, Sig Bn, Corps or Abn Corps (2)  
 11-17A, Rad-Msg Cln Opr Co (2)  
 11-57, Armd Sig Co (2)  
 11-95, Sig Bn-Opr (2)  
 11-99, Msg Cen Opr Co, Sig Bn (2)  
 11-117A, Sig Spt Co (2)  
 11-127, Sig Rep Co (2)  
 11-128A, Sig Depot Co (2)  
 11-500A (AA-AE), Sig Svc Org (2)  
 11-537A, Sig Co, Amph Spt Brig (2)  
 11-557A, Abn Sig Co (2)  
 11-587A, Sig Base Maint Co (2)  
 11-592A, Hq&Hq Co, Sig Base Depot (2)  
 11-597A, Sig Base Depot Co (2)  
 17A, Armd Div (2)  
 17-1, Hq Armd Div (2)  
 17-2, Hq Co, Armd Div (2)  
 17-22A, Hq&Hq Co, CC (2)  
 17-25A, Tk Bn, 90mm Gun (2)  
 17-26A, H&S Co, Tk Bn, 90mm Gun (2)  
 17-35, Tk Bn, 120-90mm Gun (2)  
 17-36, H&S Co, Tk Bn, 120-90mm Gun (2)  
 17-45, Recon Bn, Armd Div (2)  
 17-46, H&S Co, Recon Bn, Armd Div (2)  
 17-51, Armd Cav Regt (2)  
 17-52A, Hq&Hq Co, Armd Cav Regt (2)



17-55, Armd Cav Recon Bn (2)  
17-56A, Hq&Hq Co, Armd Cav Recon Bn  
(2)  
17-57, Recon Co (2)  
17-127A, Amph Trac Co (2)  
20-45A, Scout Bn, A, Ng (2)  
20-46A, Hq&Hq Det, Scout Bn, A NG (2)  
20-47A, Scout Co, Bn, A, NG (2)  
20-300A, Amph Spt Brig (2)  
20-301A, Hq&Hq Co, Amph Spt Brig (2)  
20-511, Amph Spt Regt (2)  
33-2, Hq&Hq Co, Sp Forces Gp, Abn (2)  
44-75, AAA Auto Wpn Bn, Sp (2)  
44-76, Hq&Hq Btry, AAA AW Bn, Sp (2)  
44-77, AAA Auto Wpn Btry, Sp (2)  
44-145, AAA Msl Bn (2)  
44-147, AAA Msl Btry (2)

51-2, Hq Co, A (2)  
52-2A, Hq Co, Corps or Abn Corps (2)  
55-37, T Amph Trk Co (A or Comz) (2)  
55-56, Hq&Hq Det, Hcptr Bn A (2)  
55-57, T Lt Hcptr Co (2)  
55-87, T Aerial Trammway Co (2)  
55-457, T A Acft Maint Co (2)  
55-458, T A Acft Hv Maint & Sup Co. (2)  
55-515A, T Boat Bn (2)  
55-517A, T Boat Co (2)  
55-555A, T Boat Maint Bn (2)  
55-557A, T Boat Maint Co (2)  
57, Abn Div (2)  
57-2A, Hq Co, Abn Div (2)  
57-19A, AT Plat, Abn Div (2)  
57-57, Recon Co, Abn Div (2)

*NG*: None.

*USAR*: None.

Unless otherwise noted, distribution applies to CONUS and overseas.

For explanation of abbreviations used, see SR 320-50-1.





**TM 11-612/TO 31R2-2PRC-101 RADIO SETS AN/PRC-8, -8A, -9, -9A, -10, AND -10A, OPERATION AND ORGANIZATIONAL MAINTENANCE—1954**